

# 旭台



SHI TAI STEEL

# 浪板

# 2022



- 九陽防火彩色鋼板
- 城寶石藝術壁板
- 琉璃瓦系列
- 各式鋼板系列
- 壁板系列
- 企口板

本型錄僅供參考，產品顏色以實際商品為主



## 目錄 Index

1	SP-700型彩色鋼板屋頂系列
3	SP-700型複合鋼板
4	800型複合壁板
5	九陽防火彩色複合鋼板
6	組合式防火系列-組合式防火屋頂板
7	組合式防火屋頂板、組合式防火外牆板
8	屋頂板730-B型絞合式鋼板
9	730型角浪清板、690型絞合式清板
10	750型琉璃瓦系統
11	750型高層次琉璃瓦、藝術水槽
12	琉璃瓦附件
13	740型十全溝清板
14	750型三溝清板、PU、雙層
16	800型清板(平面、波浪、寬溝)
17	750型四溝拱型藝術鋼板
18	760型五溝雙層鋼板
19	750型五溝清板配件、四溝清板
20	750型貨櫃板
21	720型清板、OPP
22	950型清板
23	430-A型螺旋隱藏式鋼板
24	430-B型扣合式清板
25	425型絞合式清板(可彎弓)
26	760型磚型壁板(清板、PU)七溝、素面壁板-清板(沖孔：有吸音效果)
28	385型城寶石、彩寶石藝術壁板
29	395型日式壁板(神彩、永恆、光輝)
30	307型隱藏式連續壁板、660型連續壁板
31	350型磚型壁板結合示意圖
32	350型磚型壁板、壁板系列
34	205型壁板、麒麟板系列
36	270型企口板
37	260型圓浪企口板、153型企口板
38	50、75型樓承板
39	樓承板附件擋泥、封口板、CNN油壓折床(白鐵天溝)
40	鋁副料修邊條圖示

# 防火板

內政部營建署半小時防火時效



一體成型，可做外露式及隱藏式加帽蓋

## SP-700型彩色鋼板屋頂系列

● 清板用固定座



● 止水條



● 簷口封板



● 中脊封板



● 帽蓋用固定片



● 帽蓋



隱藏式帽蓋施工順序

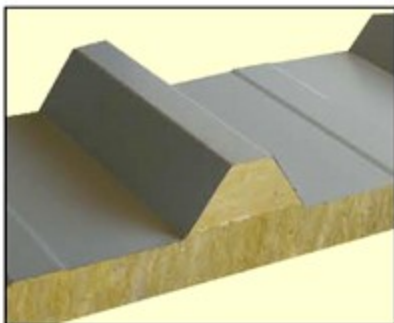

(1) 帽蓋組合圖

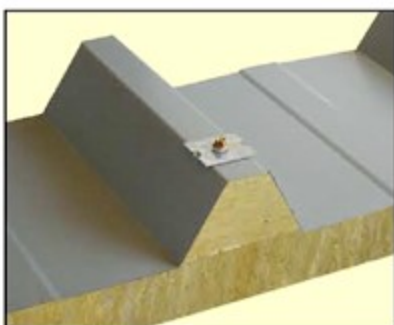

(2) 帽蓋組合圖



(3) 帽蓋組合圖

簷口封板施工



岩棉厚度：5公分



背面材質-白色烤漆鋼板

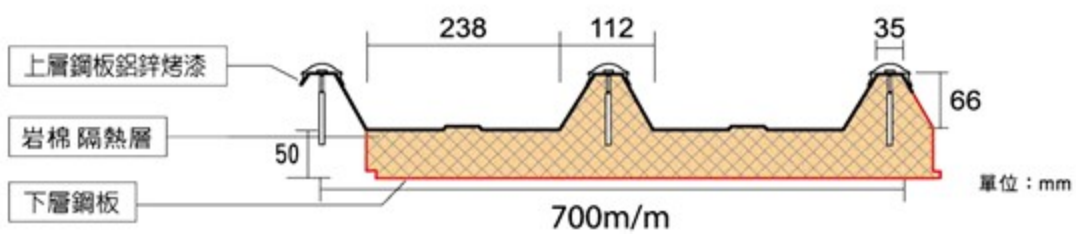

## SP-700 型



雙層厚度：3公分、5公分  
背面材質(白色烤漆鋼板)



PU厚度：3公分  
背面材質-PU(PVC紙)



使用實景

PU雙層5公分可搭接防火5公分岩棉，更具整體感

## 雙層系列

### ● 簷口封板施工

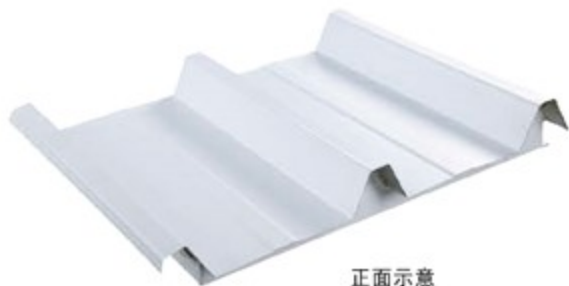

正面示意

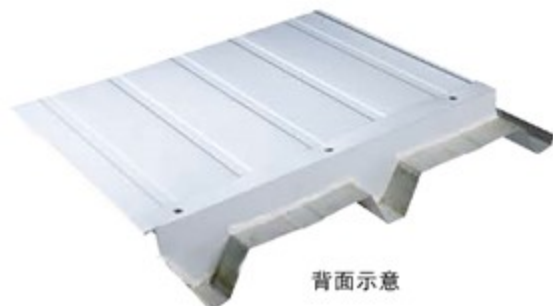

背面示意

◎可先於廠內安裝簷口封板

# 800 型

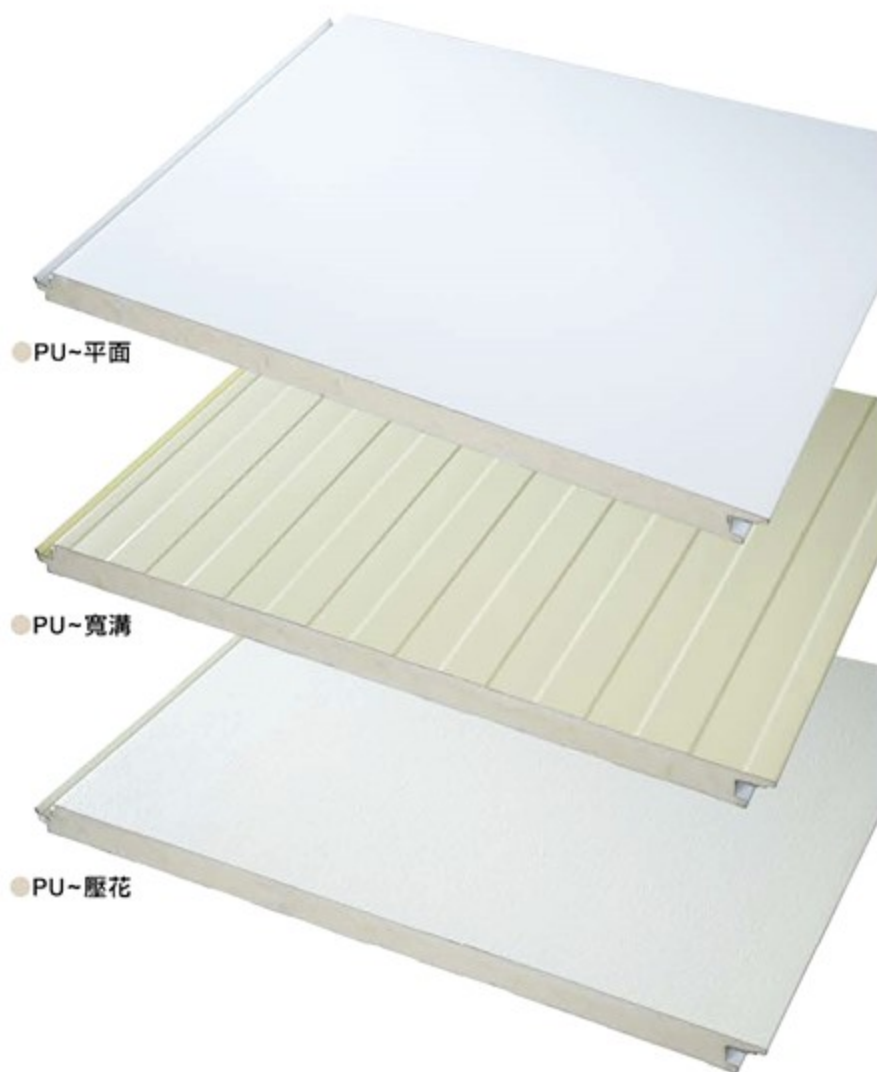

一體成型施工簡易，具有隔熱效果



雙層底板(壓溝)



結合示意



波紋面板(消光灰)

## 複合壁板 (起步條組合示意)

起步條組合示意



# 800 型

內政部營建署1小時防火時效

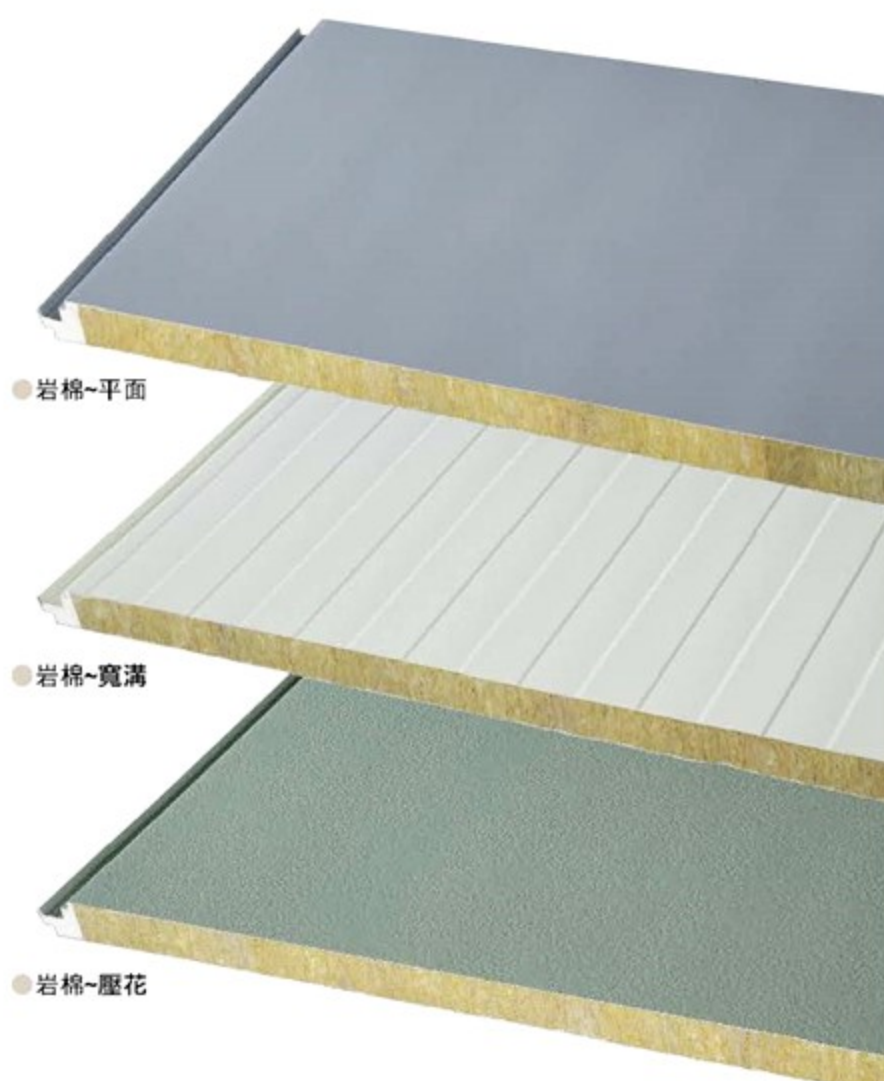

防火底板(平面)



結合示意



波紋面板(消光灰)

一體成型施工簡易，降低施工成本

## 九陽防火彩色複合鋼板



單位：mm

## 組合式防火系列

內政部營建署半小時防火時效

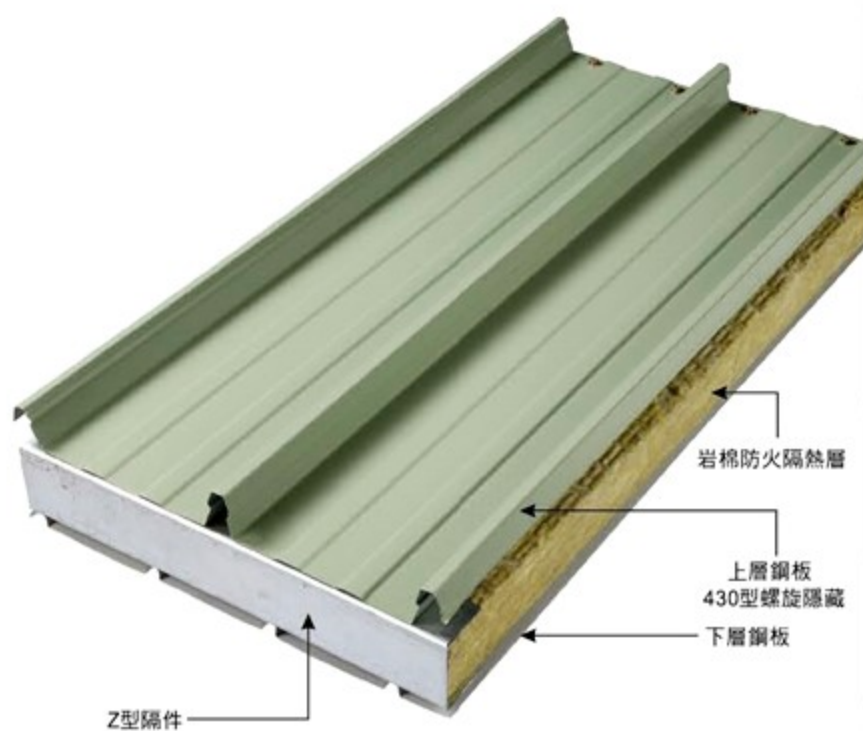

下層鋼板背面  
(770型素面壁板)

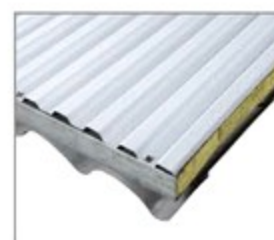

下層鋼板背面  
(740型十全溝清板)

上層鋼板選擇更多樣性

## 組合式防火屋頂板





## 組合式防火屋頂板

內政部營建署半小時防火時效

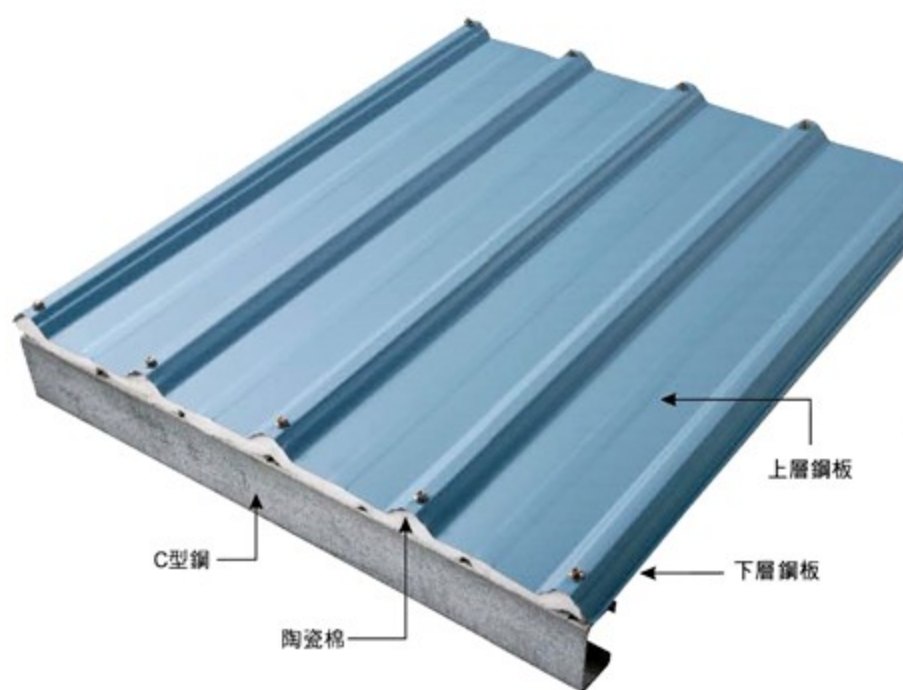

Z型鋼局部圖(規格可調整)

## 組合式防火外牆板

內政部營建署1小時防火時效

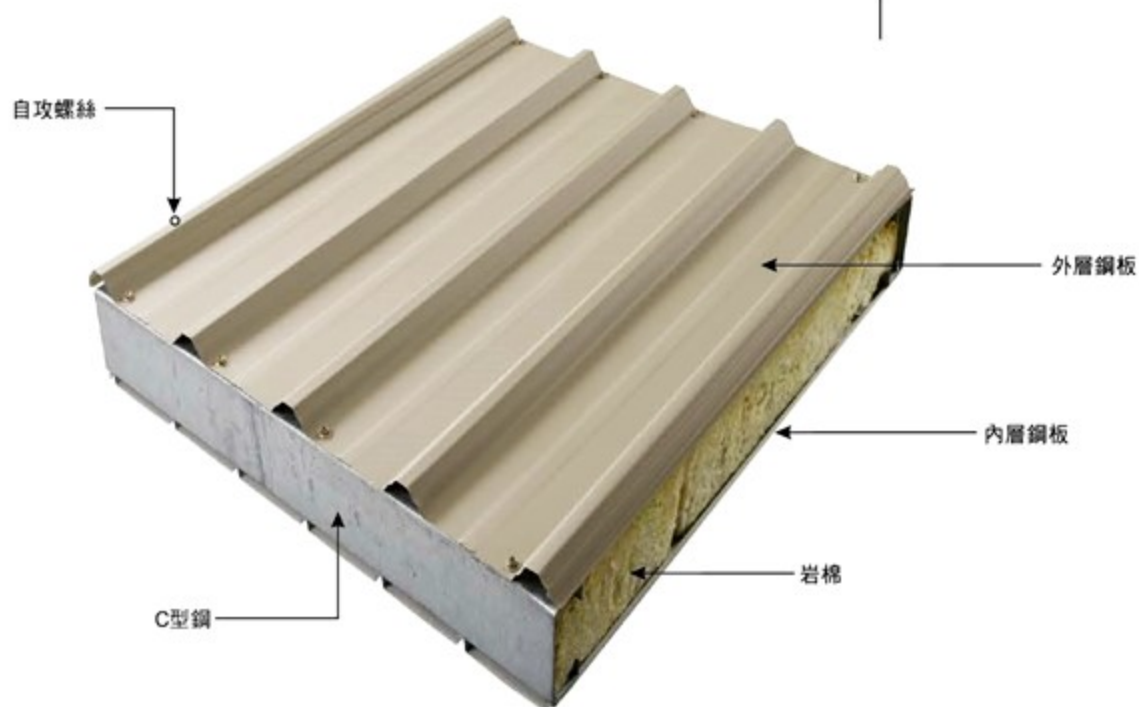

## 730-B 型



絞合式鋼板適用於大面積屋頂使用

## 屋頂板-絞合式鋼板

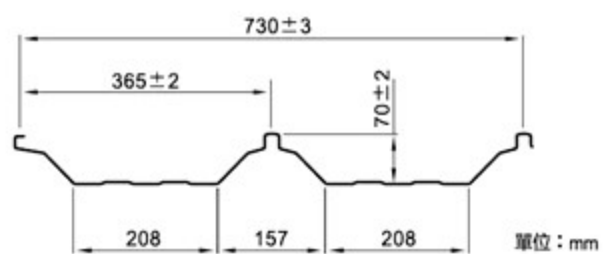

● 手動絞合具



● 電動絞合機



固定座

● 固定座組合示意

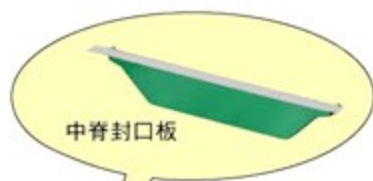

中脊封口板

● 中脊封口板組合示意



● 簷口封板

## 730 型

不同一般鋼板，角浪板型是SMP、PVDF最佳保護者，適用於高張力鋼板

### 角浪清板

- 高強板730mm
- 一般板710mm

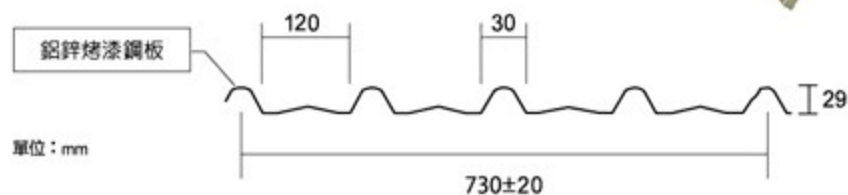

#### 附件



### 690 型 絞合式清板

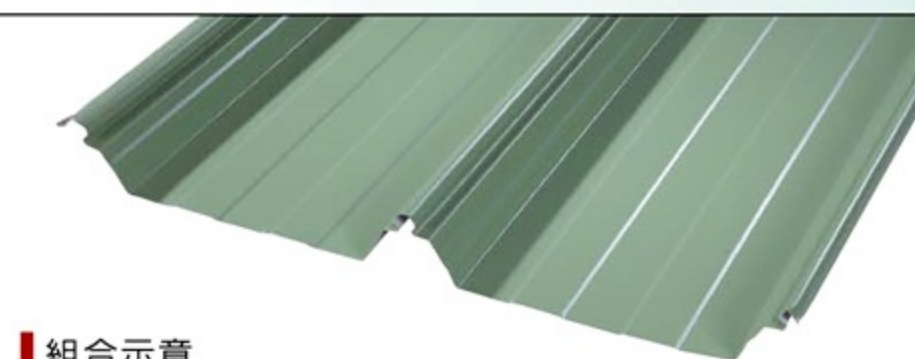

#### 組合示意

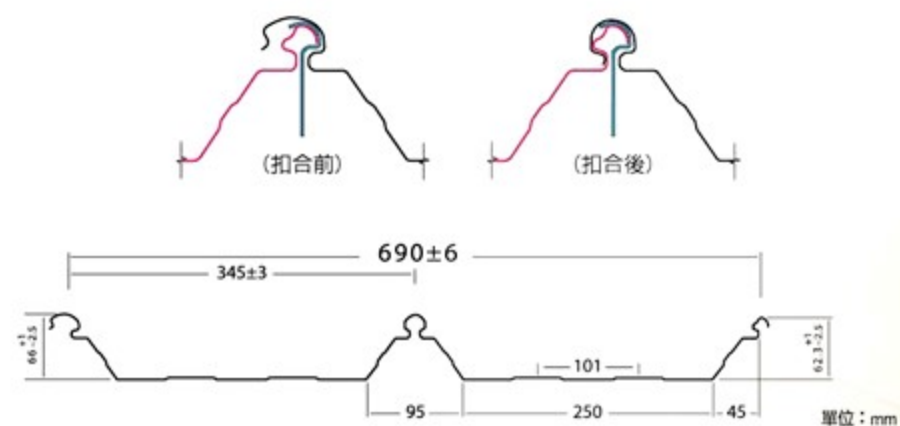

# 750 型

具有傳統建築之美的瓦型鋼板，施工簡易

## 琉璃瓦系列

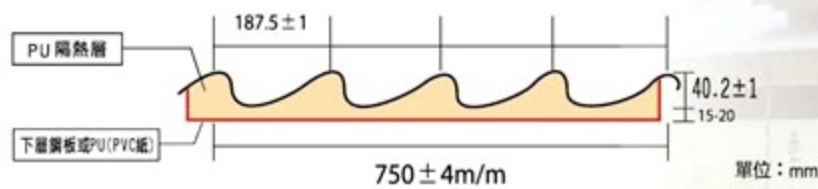
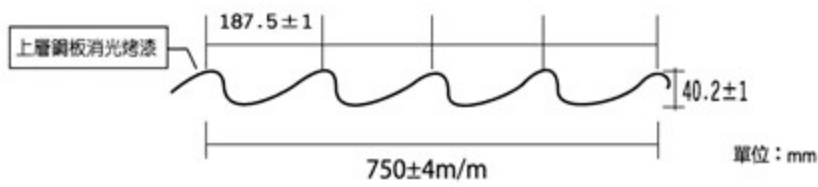

■ 清板

■ 發泡

■ 雙層



背面材質-PU(PVC紙)



背面材質-白色烤漆



750 型

## 高層次琉璃瓦



- 高層次  
(瓦深25mm)
- 清板
- 雙層

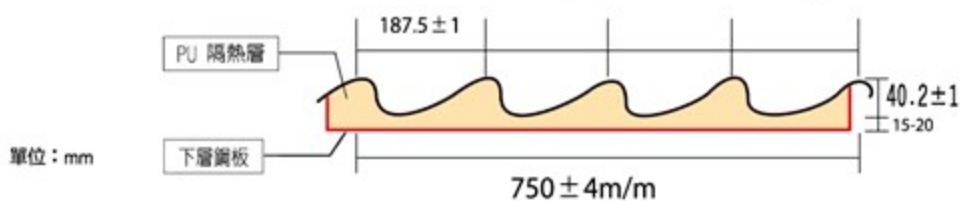

## 藝術水槽

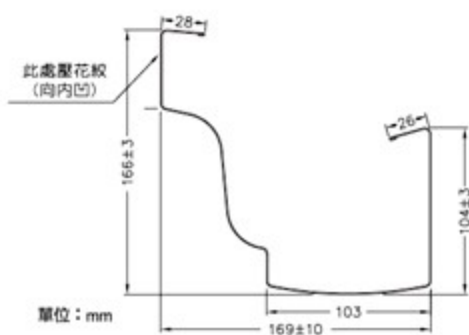

● 端蓋(不銹鋼)



● 端蓋(白鐵烤漆)

鋼瓦多樣性配件，具有古典建築物之美

## 琉璃瓦系列

### ■ 附件

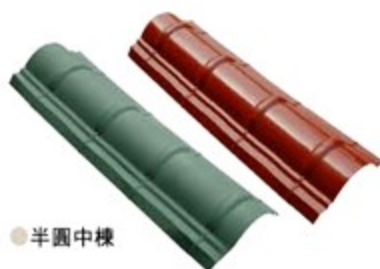

## 740 型

■ 清板 (銀)

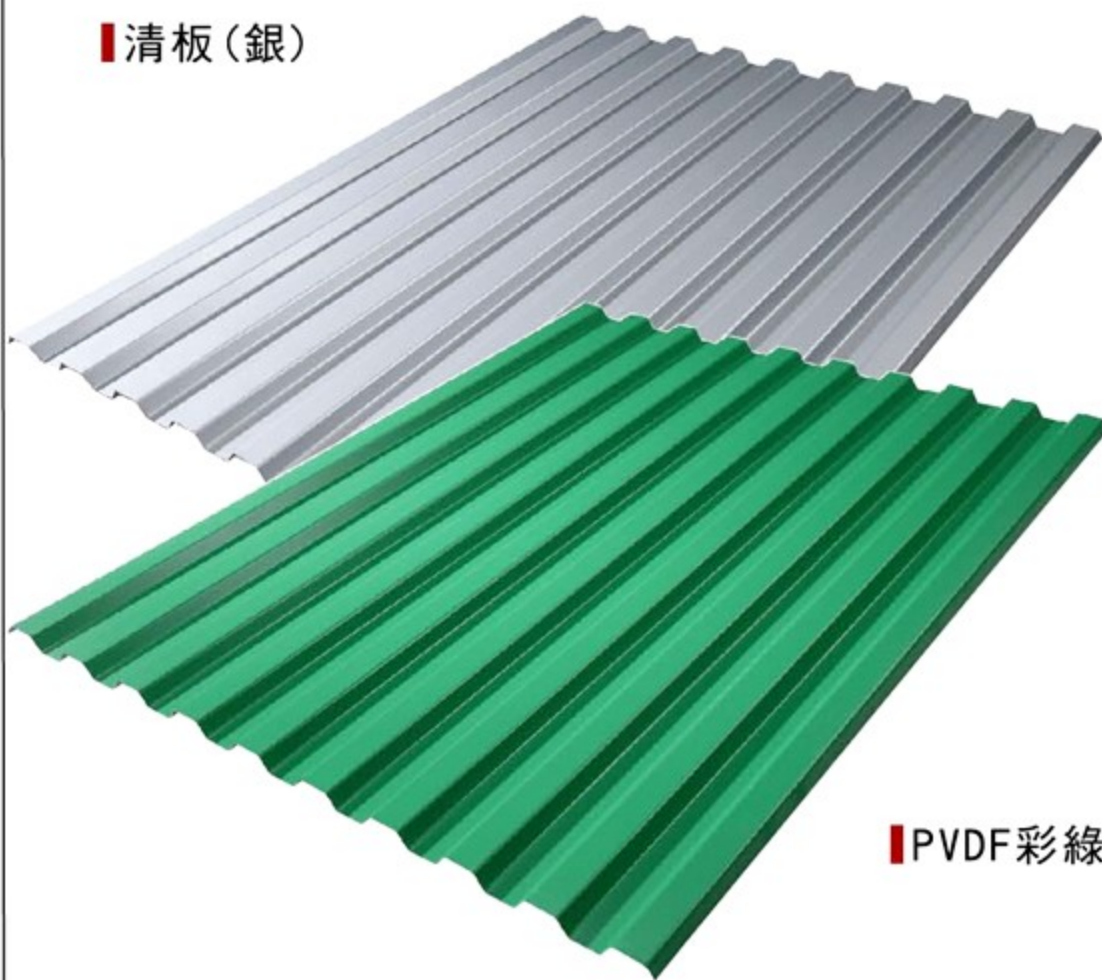

■ PVDF彩綠

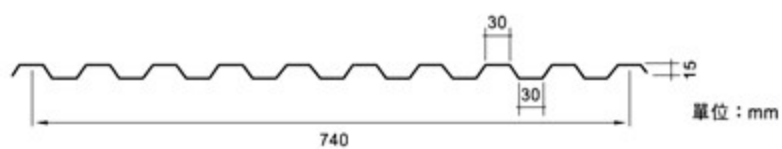

堅硬度佳，適合用於組合式防火板底板

## 十全溝清板

使用實景



● 740型十全溝清板-止水條

# 750 型

凸槽深度較高，排水性佳，施工簡易、節省成本（可隱藏式加帽蓋）

## 三溝清板、PU、雙層

### 清板

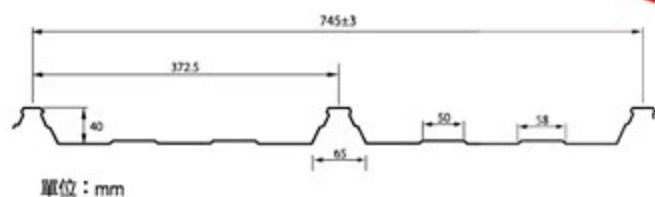

### PU發泡

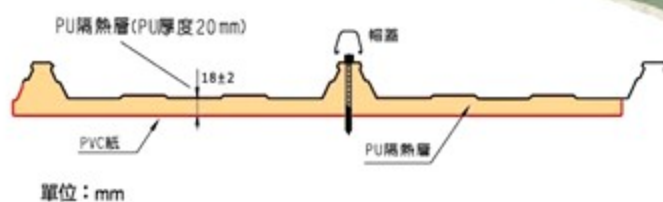

### 雙層

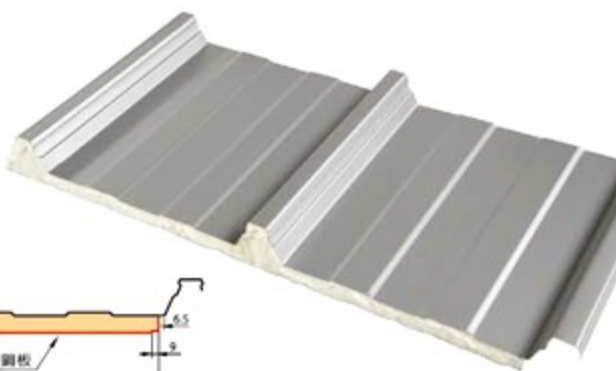
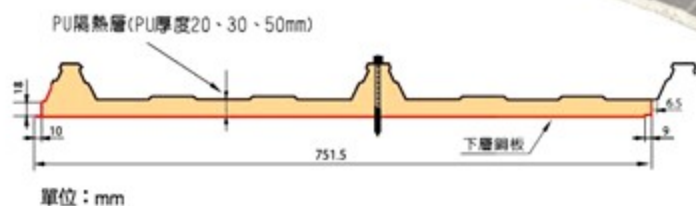

使用實景





## 三溝清板、PU、雙層



一般外露式



鎖上自攻螺絲

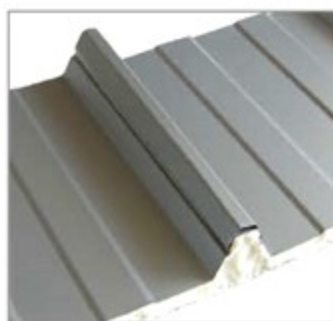

加上帽蓋(隱藏式)

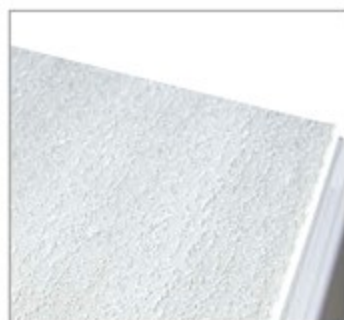

背面材質-PU



背面材質-白色烤漆鋼板

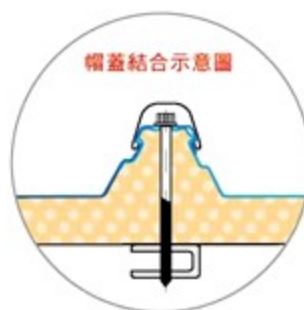

### ● 750型帽蓋組合圖

### ■ 附件



● 750型三溝-白鐵PC壓板



● 750型三溝-端蓋(鐵製)  
(厚度2公分適用)



● 750型三溝透明PC板(抗UV)



● 三溝止水條

800 型

清板

新產品

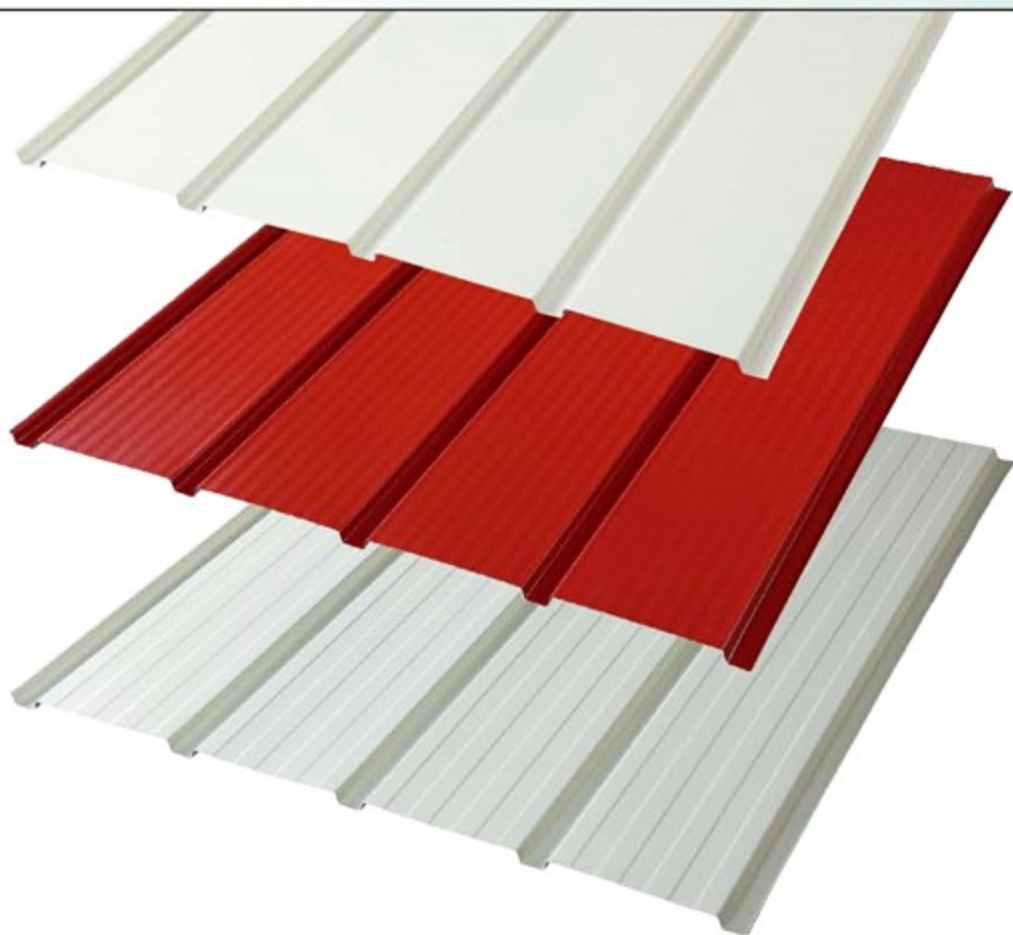

■ 平面

■ 波浪

■ 寬溝

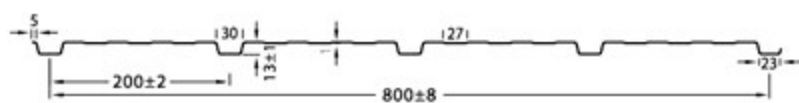
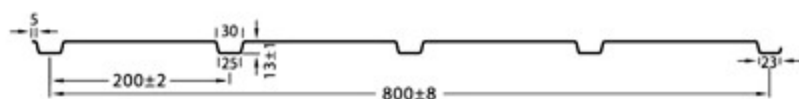

單位：mm

750 型

# 四溝拱形藝術鋼板

新產品

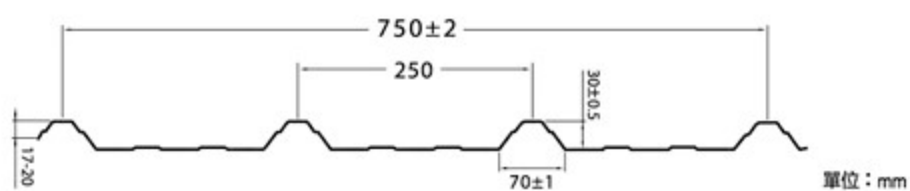
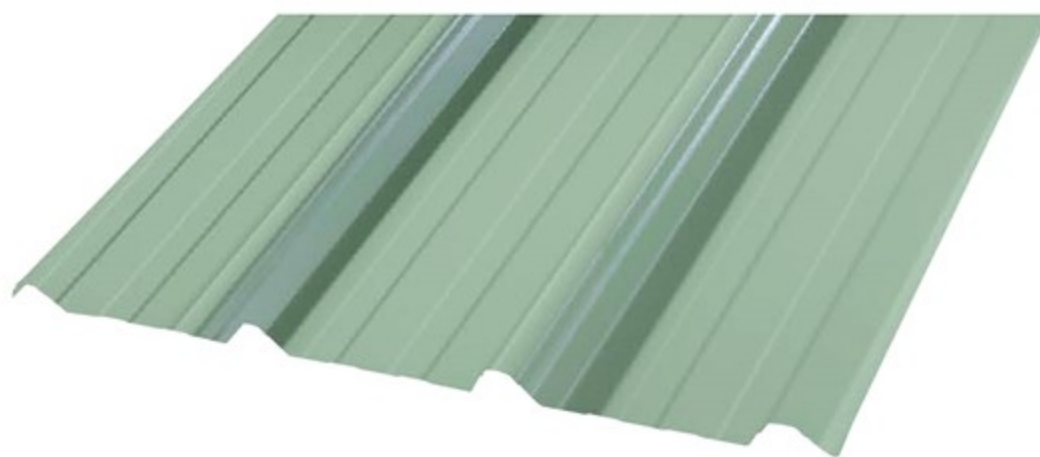
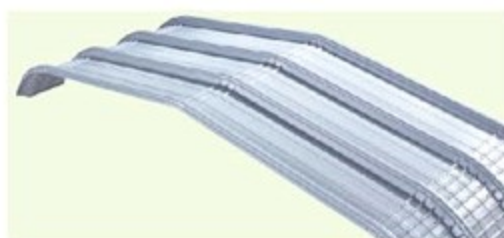
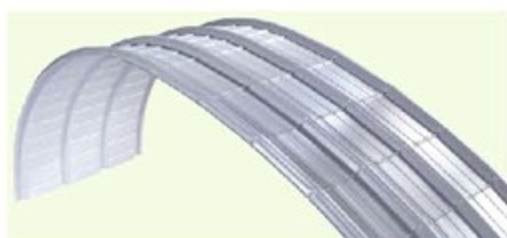
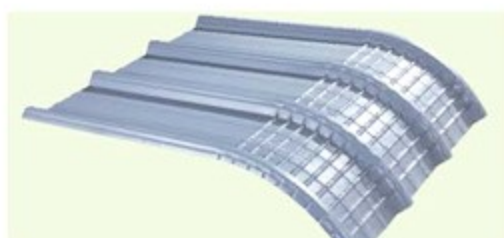
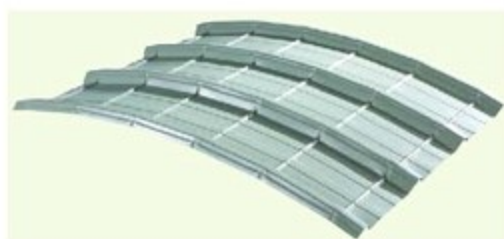
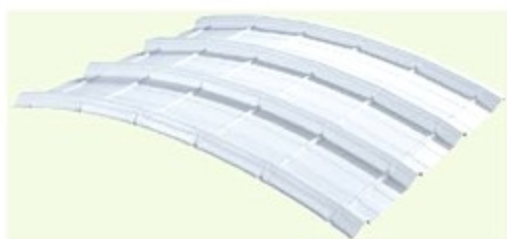

# 760 型

一體成型隔熱效果佳

## 五溝雙層鋼板

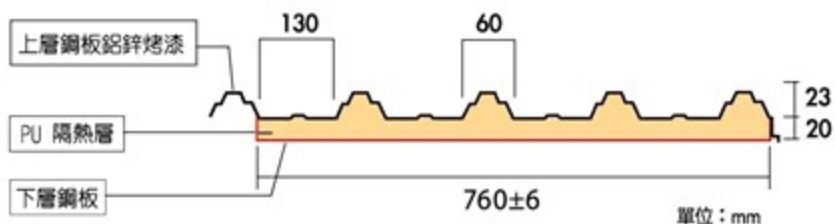
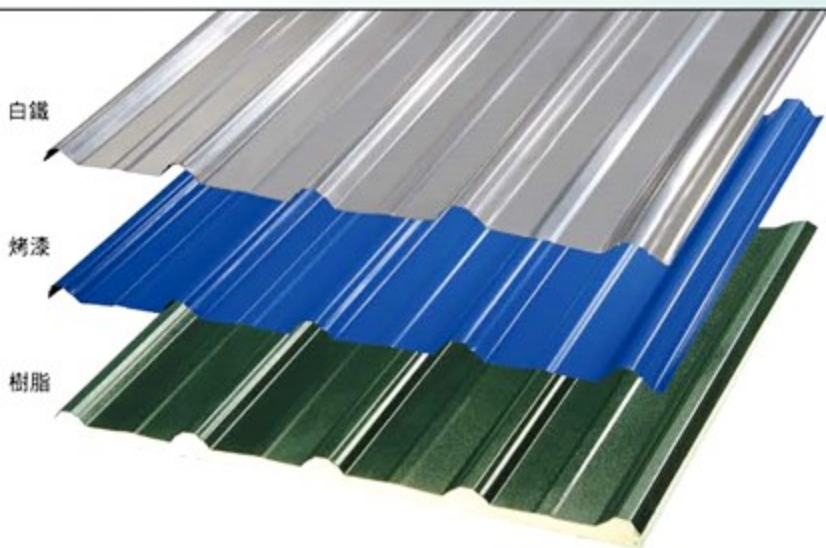

背面材質-鋼板  
(白色烤漆鋼板)

◎另有白鐵烤漆鋼板、鋁鎂合金、SMP、PVDF多種顏色可供選擇

## 五溝清板

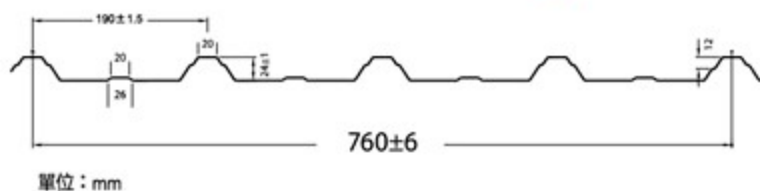

## 760型五溝配件



● 760型止水條



● 760型屋簷端蓋

## 750型五溝PC板及配件



## FRP-圓浪

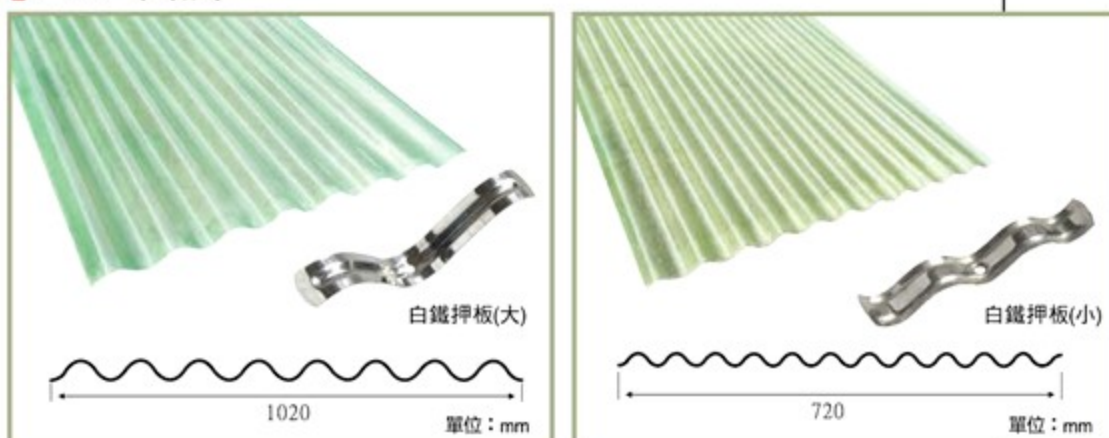

●FRP-大圓浪

●FRP-小圓浪

**780型**

施工簡易

## 四溝清板

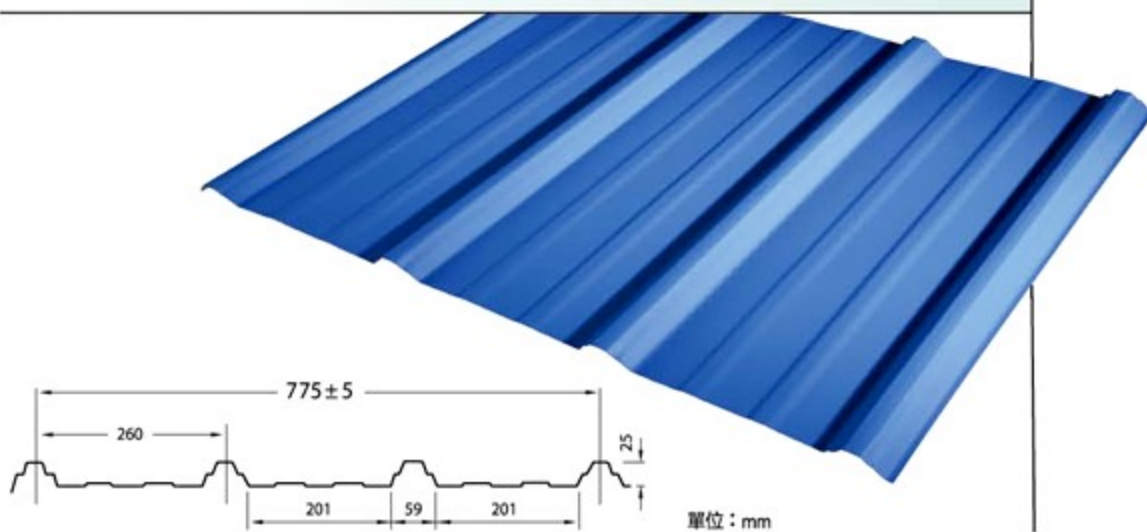

750 型

# 貨櫃板

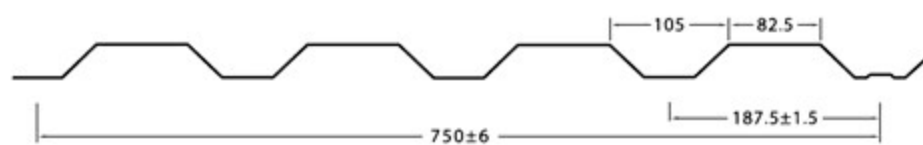

單位：mm

# 720 型

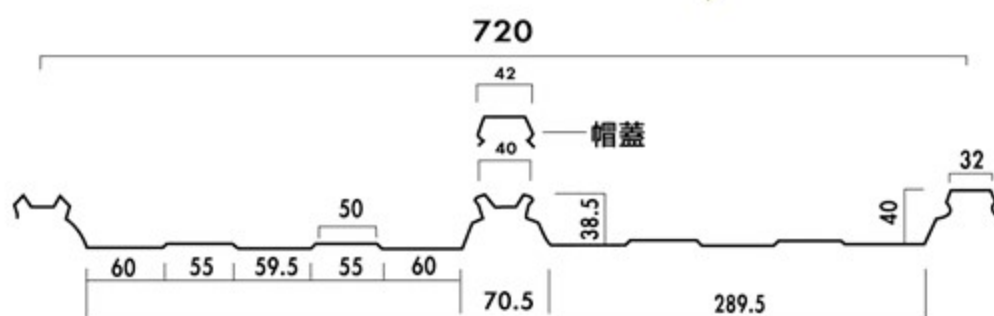

單位：mm

螺絲不外露

## 清板、OPP (隱藏式加帽蓋)

### 附件



● 720型清板用固定座



● 720型止水條

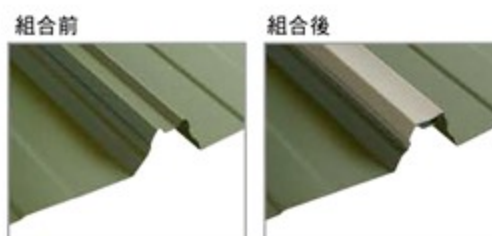

● 720型帽蓋組合圖

950 型

清板

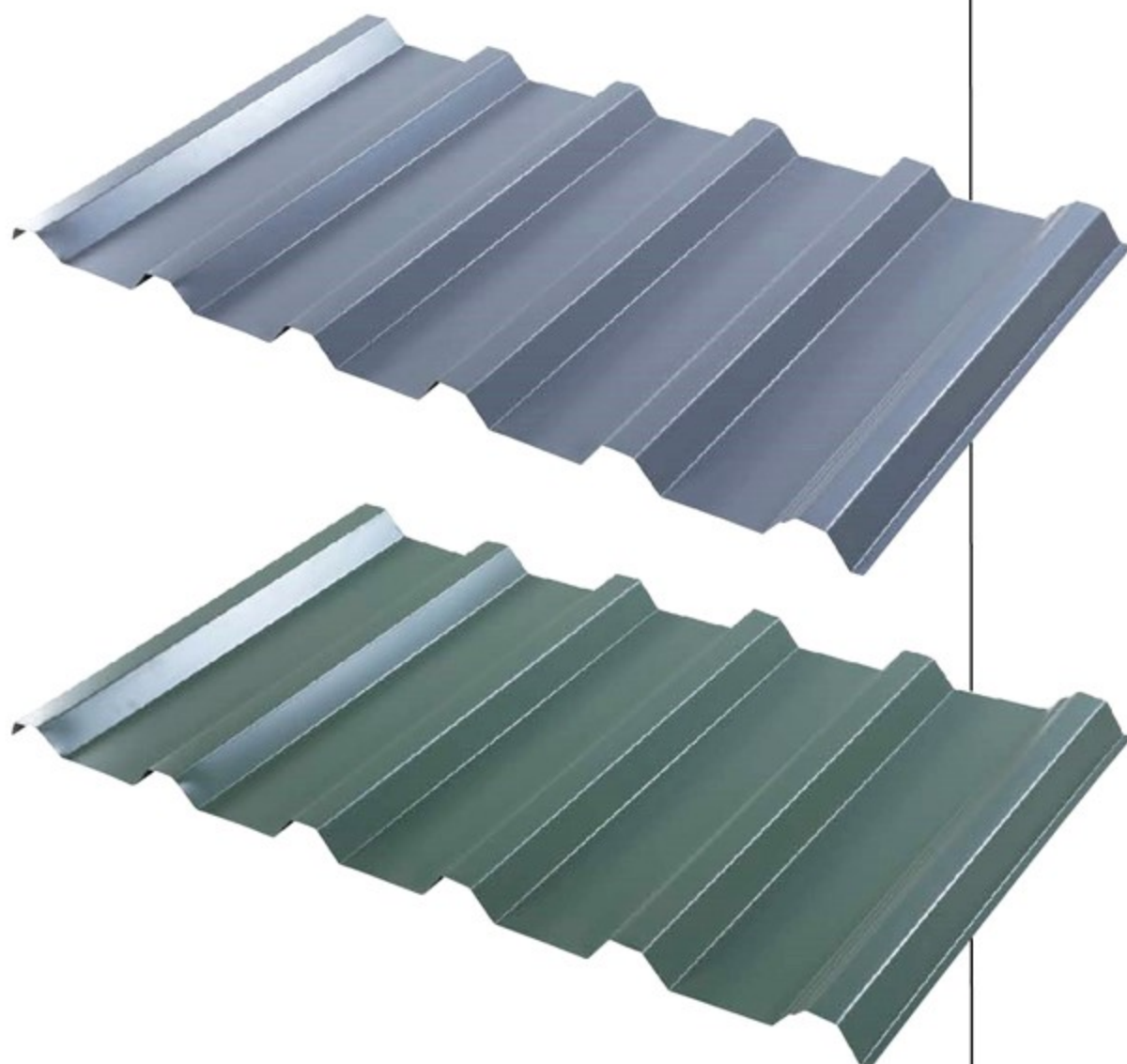



## 430-A型

隱藏式增加使用年限，適用於高張力鋼板材質

# 螺旋隱藏式鋼板

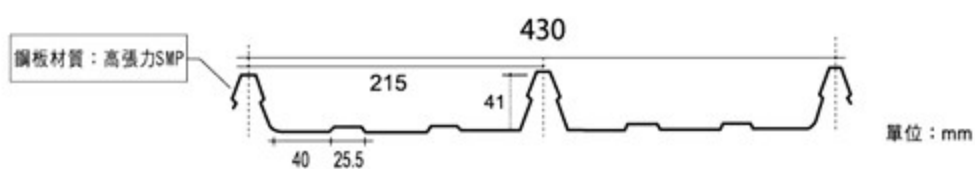

### 附件



● 430-A型固定座



● 430-A型止水條

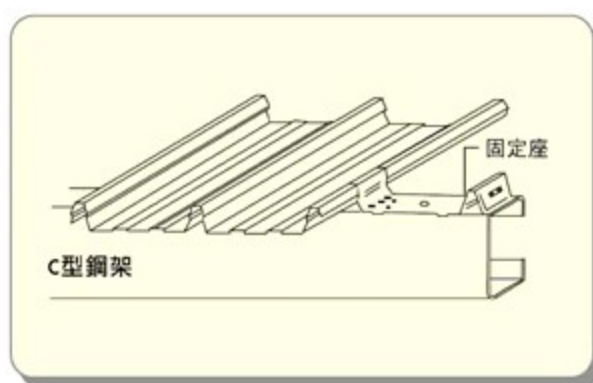

# 430-B 型

鋼板適用於大面積屋頂使用

## 扣合式清板

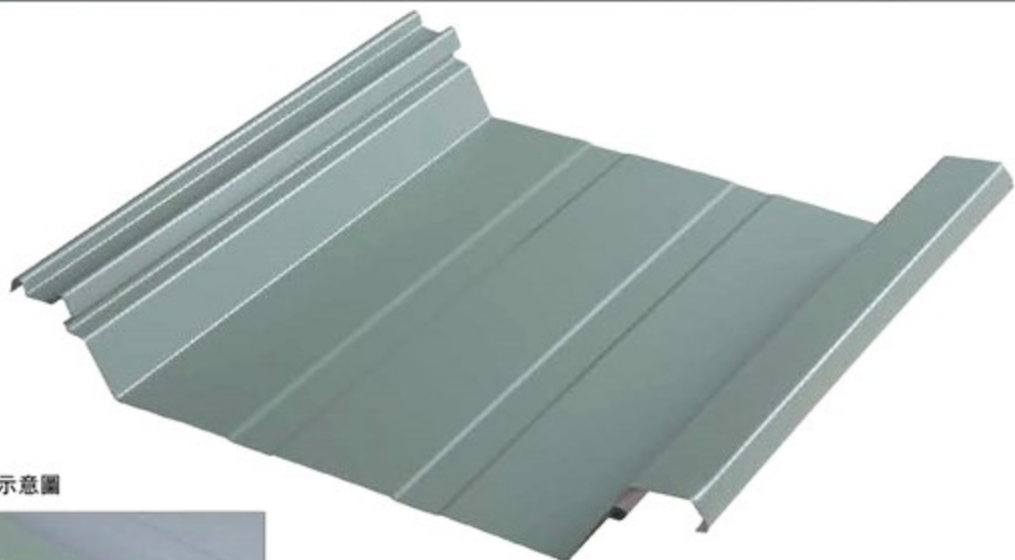

● 組合示意圖

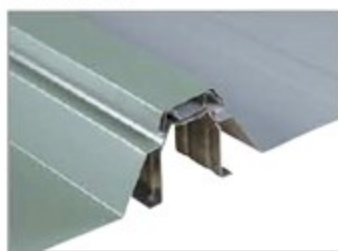

單位：mm



● 簷口封板+中脊封板組合示意圖



● 固定座



● 簷口封板+中脊封板



● 430-B型止水條

425 型

## 絞合式清板(可彎弓)

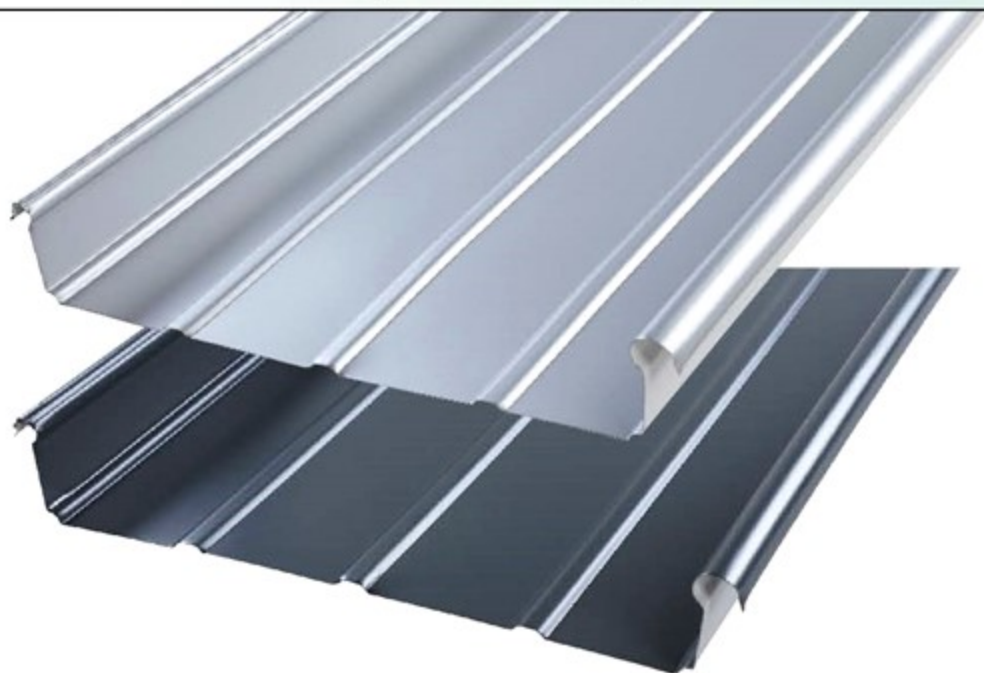

● 425型手動絞合具



● 425型止水條



● 防颱夾



● 電動絞合機



● 固定座

● 組合示意圖

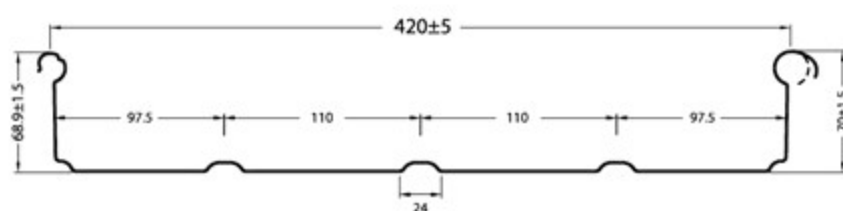
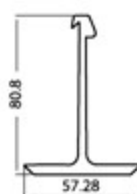
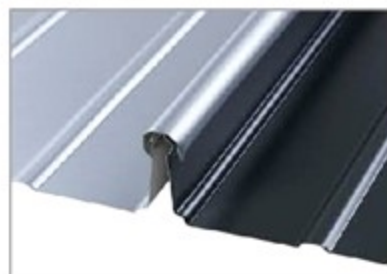

單位：mm

# 760 型

有效寬度請依實際產品確認

## 磚型壁板 (清板、PU) 七溝

二丁掛直型

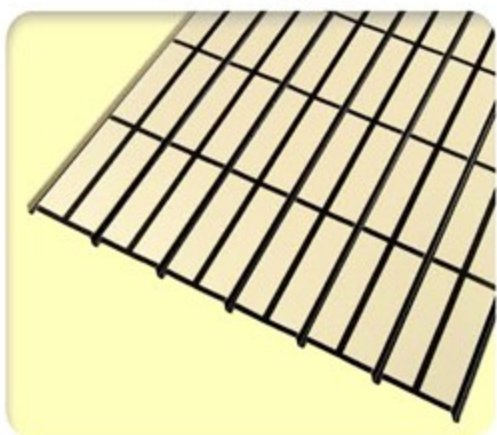

二丁掛交丁型

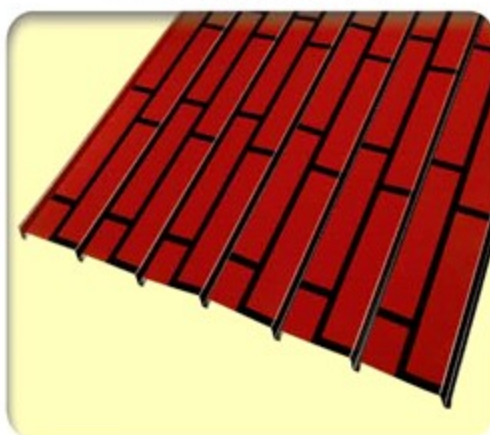

小口磚

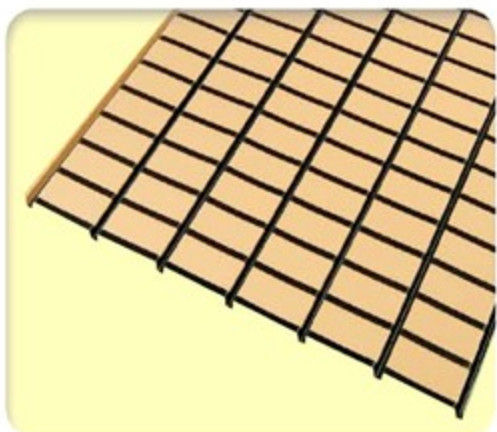

方塊磚

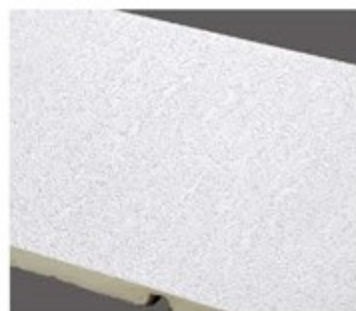
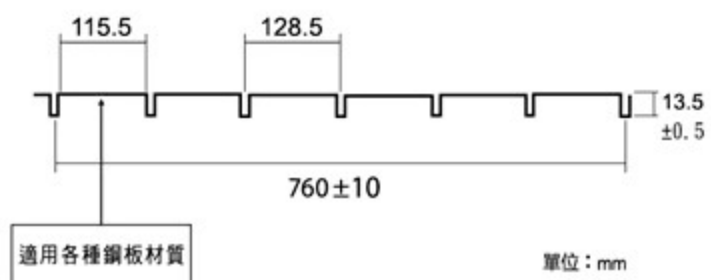
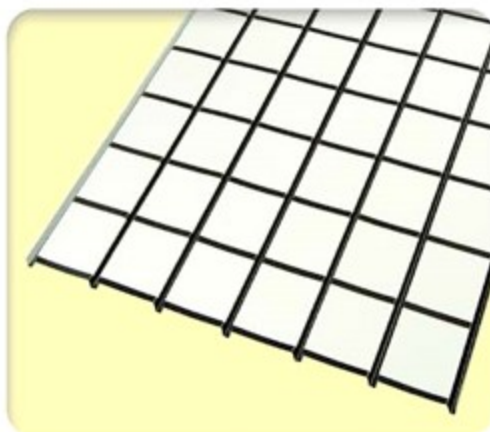

●背面材質-PU·厚度18mm(PVC紙)

美觀耐震彩色磚型壁板系列，四種樣式可供選擇

## 磚型壁板 (標式示意圖)

實內：22.8cm 含黑線：25.3cm    實內：22.9cm 含黑線：25.3cm    實內：5.3cm 含黑線：7.7cm    實內：11.6cm 含黑線：14cm

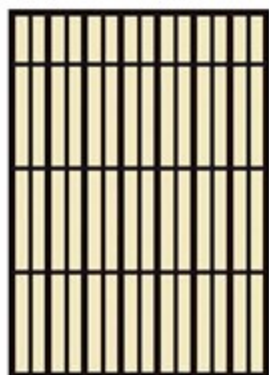

二丁掛直型

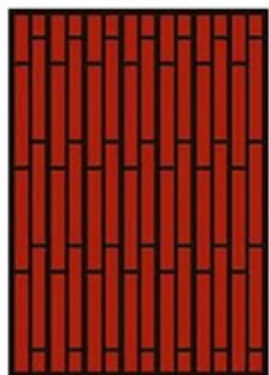

二丁掛交丁型

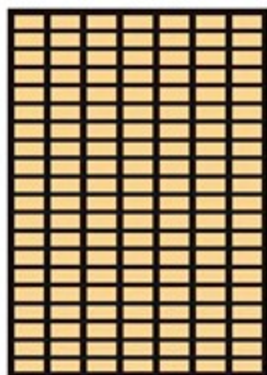

小口磚

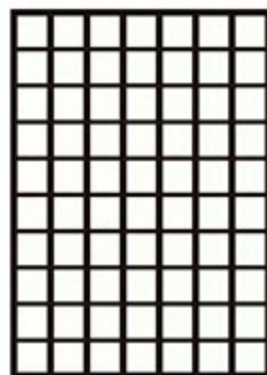

方塊磚

## 素面壁板-清板 (可沖孔)、PU

有效寬度755mm

沖孔：有吸音效果



●素面

●小波浪(平整度佳)

## 385 型

精緻典雅的壓紋增添美感

### 城寶石藝術壁板

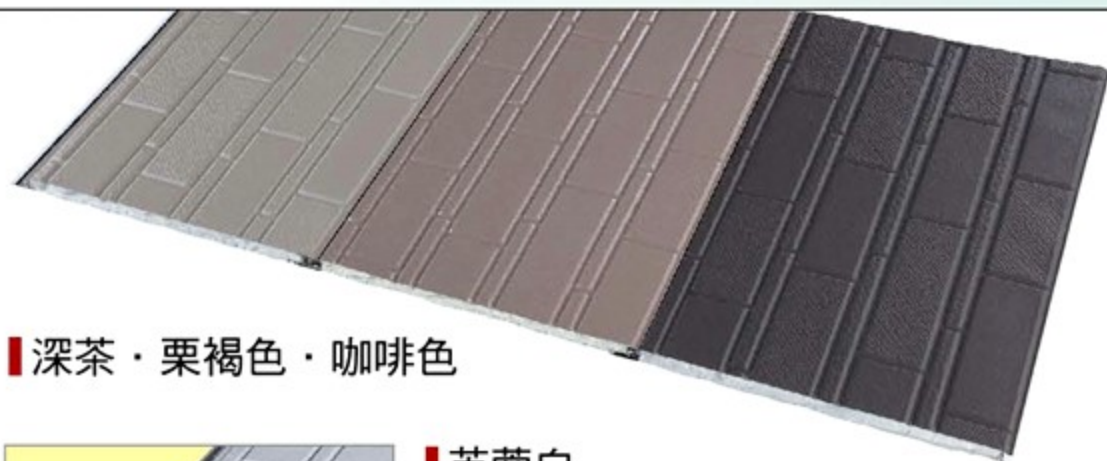

■ 深茶 · 栗褐色 · 咖啡色

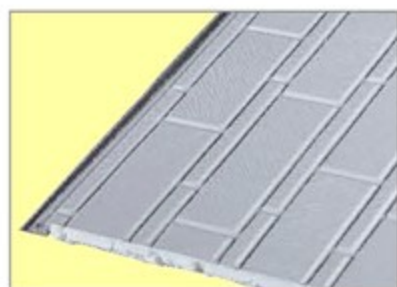

■ 芙蓉白

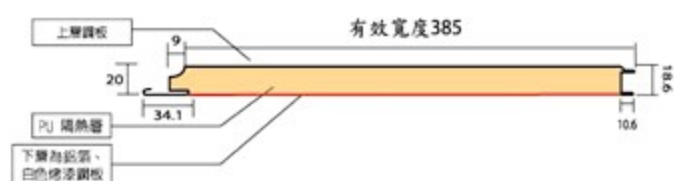

單位：mm

## 385 型

壓花藝術壁板典雅簡約風格

### 彩寶石藝術壁板 (PU厚度20mm)



深茶色



栗褐色

# 395 型

產品具有隔熱的特性，防水性佳；經濟實惠

## 日式壁板 (神彩、永恆、光輝)



芙蓉白



深茶色



咖啡色



栗褐色



■ 神彩



■ 永恆



■ 光輝



● 結合圖

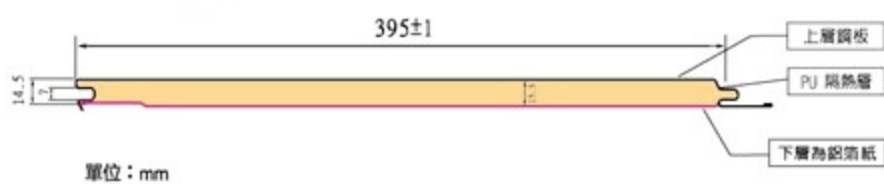

# 307 型

## 隱藏式連續壁板



### 附件



● 307型止水條

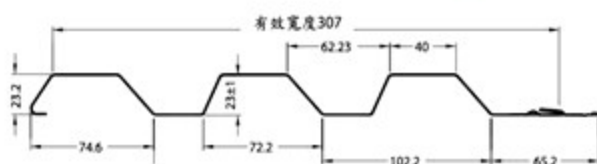
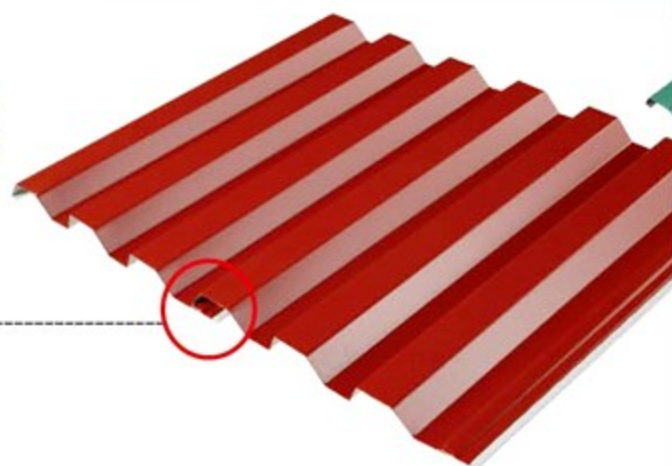

單位：mm



● 單片



使用實景

# 660 型

立體美觀更具層次感

## 連續壁板

### 附件



● 660型止水條



實景背面

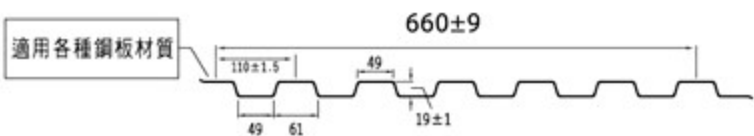

單位：mm



# 350 型

美觀耐震彩色磚型壁板系列，6種樣式可供選擇

## 磚型壁板結合示意圖

### 直式直丁型

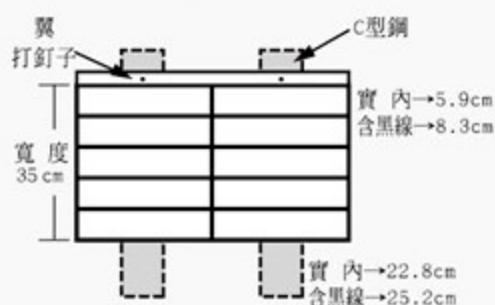

### 直式交丁型

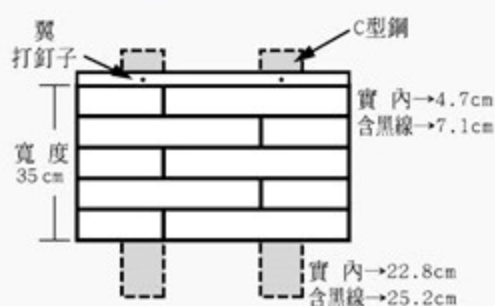

C型鋼打直，鋼板橫蓋

### 方塊磚

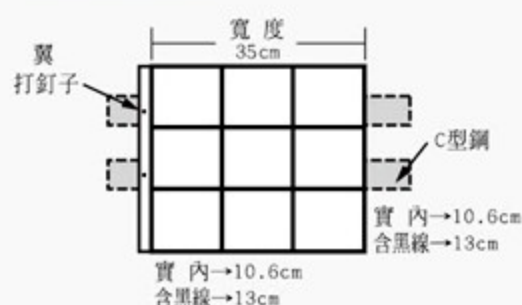

### 小口磚

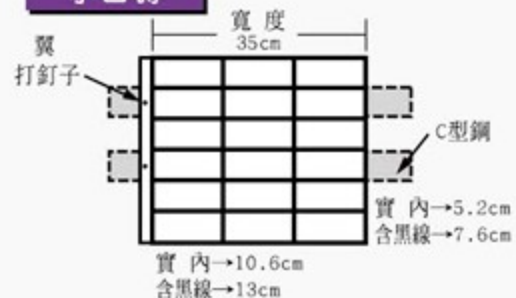

### 橫式交丁型

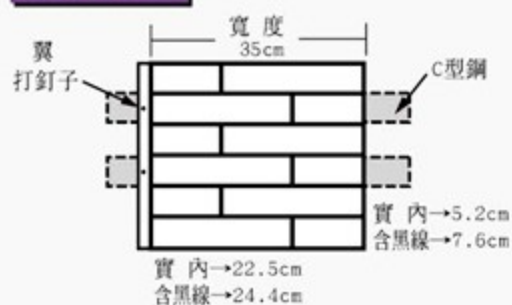

### 橫式直丁型

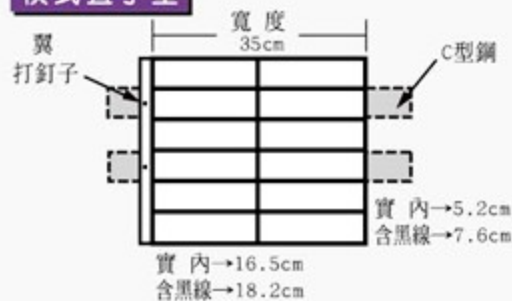

C型鋼打橫，鋼板直蓋

## 附件



●磁鋼黑釘白鐵410

# 350 型

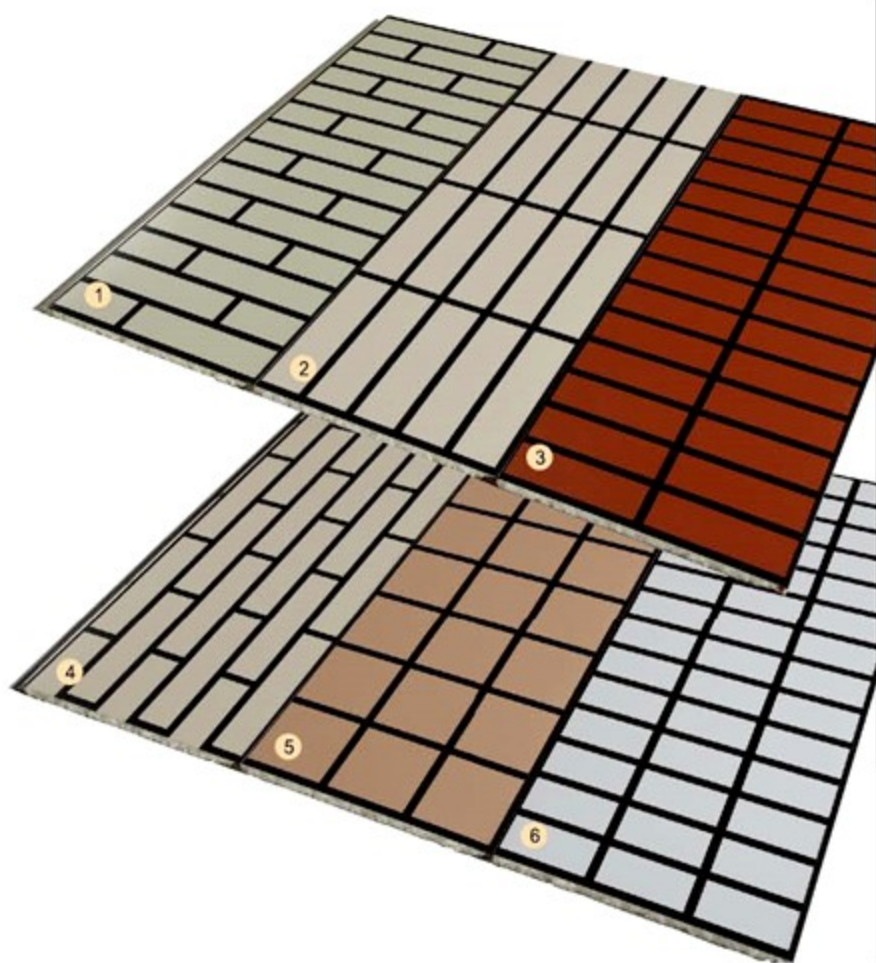

1. 橫式交丁型
2. 直式直丁型
3. 橫式直丁型
4. 直式交丁型
5. 方塊磚
6. 小口磚

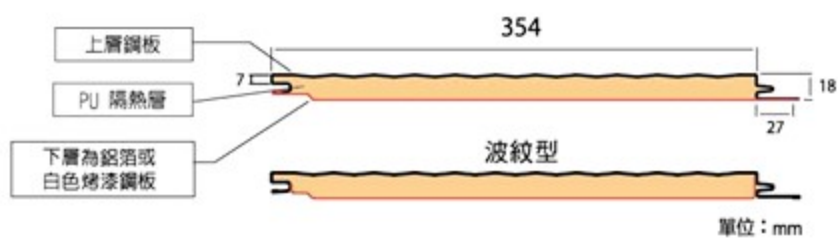

取代傳統磁磚，施工簡易，造型優雅，提供多樣化的選擇

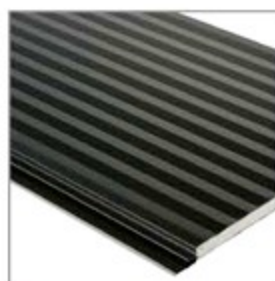

● 波紋板(消光灰)

## 磚型壁板系列

背面材質-鋁箔

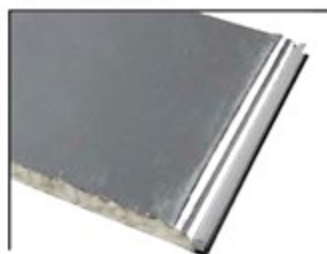

背面材質-白色烤漆鋼板



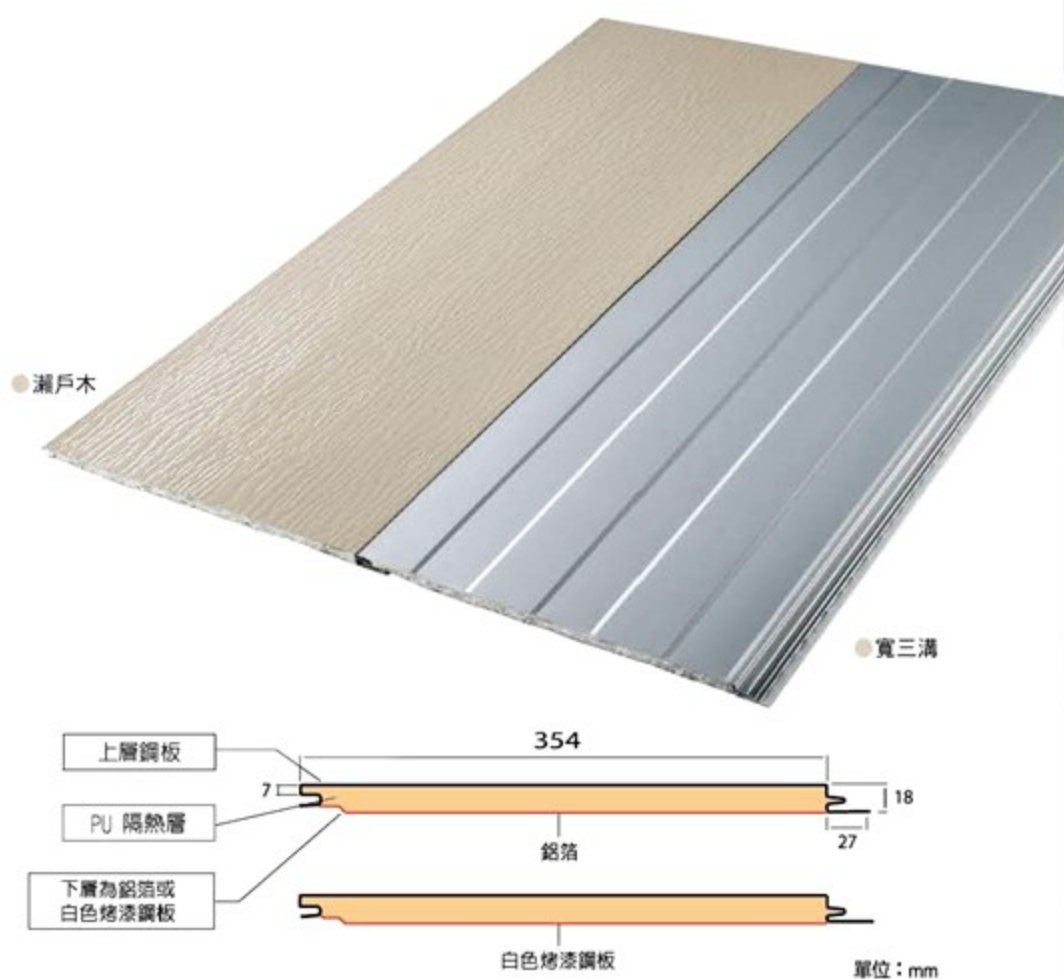

壓花紋為建築增添美感

## 壁板系列



●壓一線



●壓二線



# 205 型

立體壓花造型

## 壁板、麒麟板系列

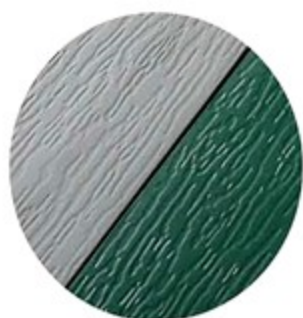

● 瀨戶木



● 楓彩紋



● 方形紋

● 楓彩系列

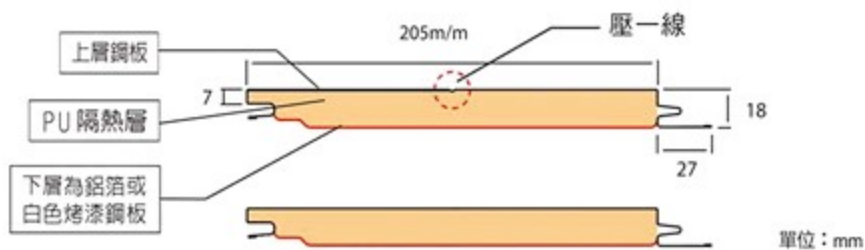

● 205型壁板斷面圖



● 紅豆杉

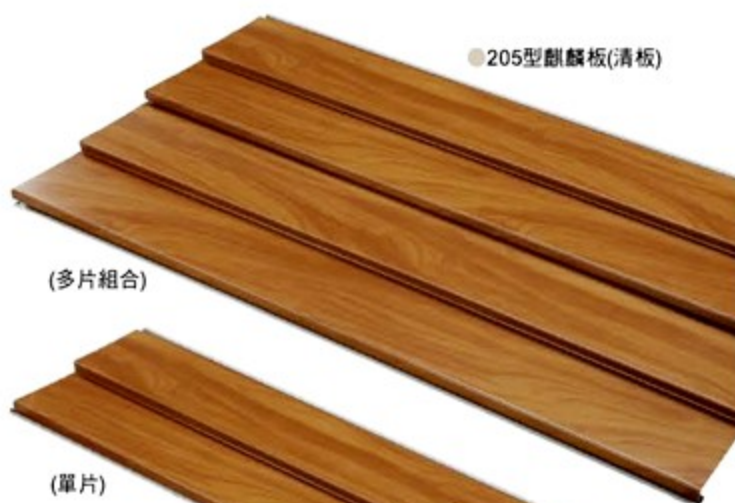

● 205型麒麟板(清板)

(多片組合)

(單片)

背面材質-鋁箔

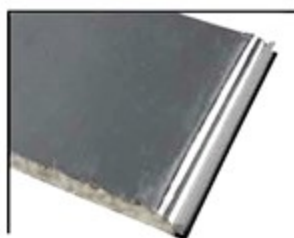

● 205型麒麟板

背面材質-白色烤漆鋼板



## ■ 附件



● 205型麒麟板-止水條

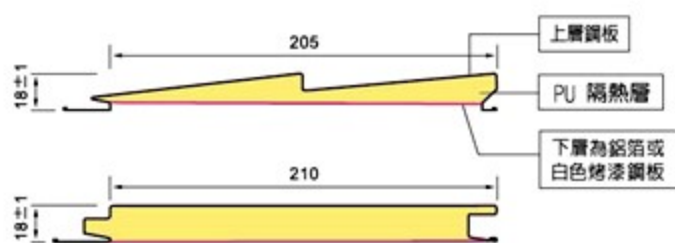

單位：mm

● 205型麒麟板斷面圖

270 型

# 企口板

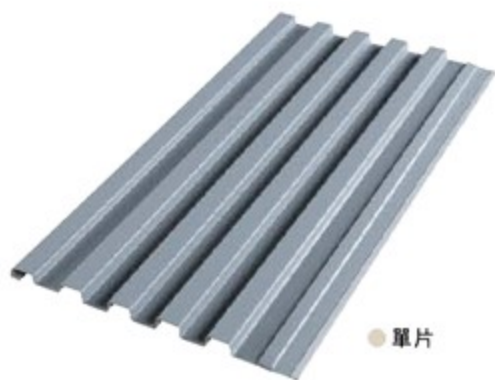

● 單片

## ■ 附件

● 止水條



● 組合示意圖

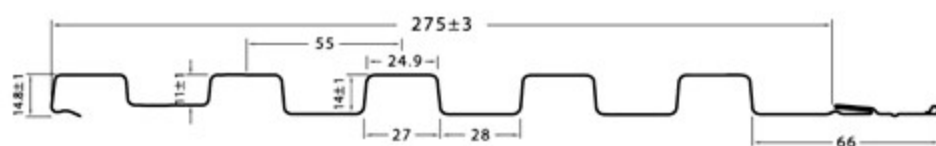

單位：mm

## 260 型

### 圓浪企口板

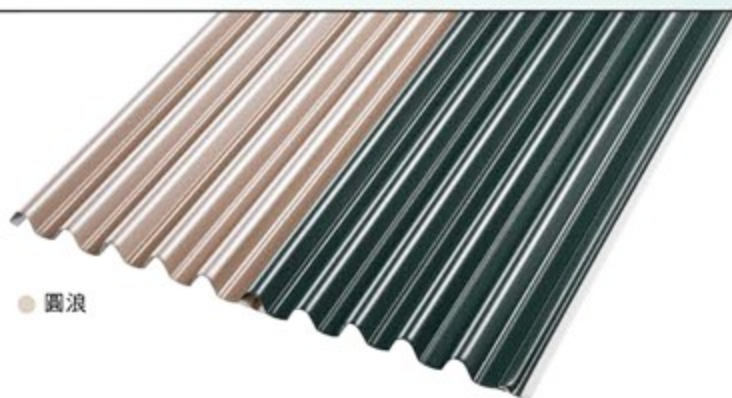

● 圓浪

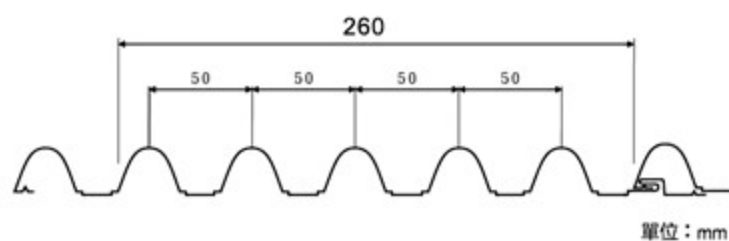

### 附件

● 260型止水條



● 153型止水條



## 153 型

### 企口板



● 多片組合

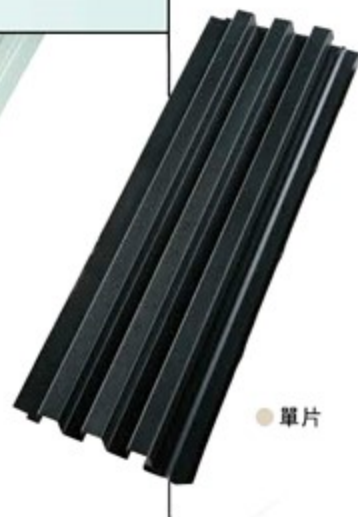

● 單片

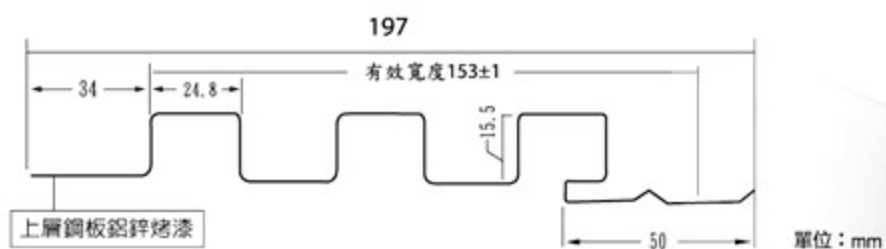

**50 型**

**75 型**

鋼板與混凝土結合性佳、不漏漿，節省鋼筋使用量，降低整體施工成本

樓承板、擋泥板、封口板、點焊網

## 50 型樓承板

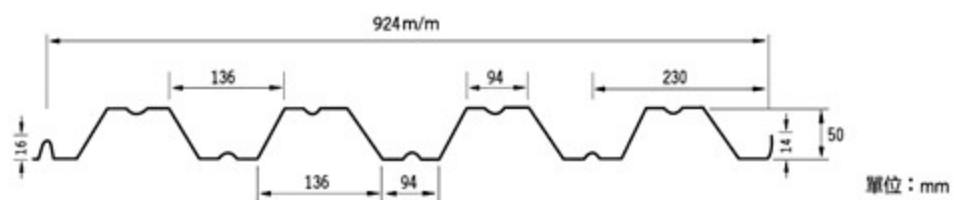

## 75 型樓承板

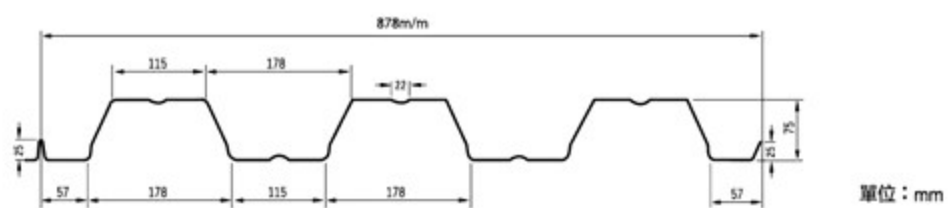



## 樓承板與封口隔板結合圖



● 50型四連式



● 75型三連式



● 75型單片式



● 樓承板-封口-50型四連式



● 樓承板-封口-75型三連式



● 樓承板-封口-75型單片式

### 擋泥板



● 擋泥板 (12公分高)



● 擋泥板 (15公分高)

## CNC油壓折床 (白鐵天溝)

種類	厚度	長度	深度
不鏽鋼	最厚2.0 t	最長6000 mm	1000mm

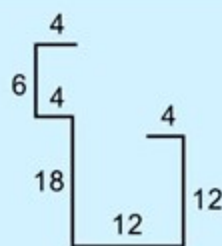

700型  
水槽(60公分)

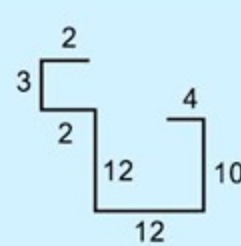

750型三溝  
水槽(46公分)

# 鋁副料修邊條圖示 (單位：mm)

●適用範圍：770型磁磚壁板(清板) 153型、205型、350型、395型、270型企口板

205淺 工字連接組合



406淺 大外角組合

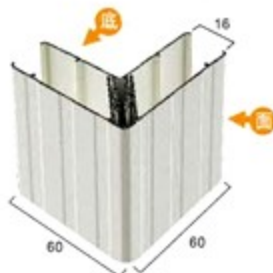

404淺 小外角組合



713淺 7字固定



704淺 7字修邊組合



813 起步條(外起底) (不可包鋼板)



●適用範圍：307型、385型城寶石壁板、770型磁磚壁板(PU)、260型圓浪企口板

205深 工字連接組合



406深 大外角組合

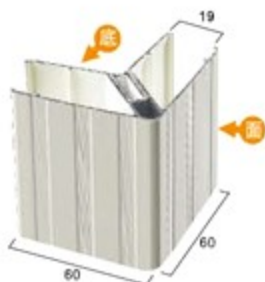

404深 小外角組合



713深 7字固定



704深 7字組合



# 鋁副料修邊條圖示 (單位：mm)

● 防火板：5公分專用

504 7字修邊組合



面寬50

505 工字連接組合



面寬60

508 大工字連接組合



面寬80

506 外轉角組合 (不可包鋼板)  
(506+704面x2)



507 大7字組合  
(不可包鋼板)



面寬80

510 大外轉角組合 (不可包鋼板)  
(510面·底+704x2)

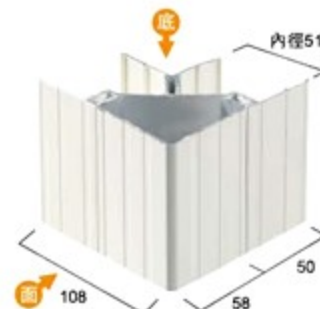

面寬108

509 方外轉角組合

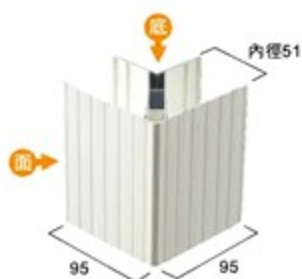

面寬95

513 起步條(毛料)  
(不可包鋼板)



單支

515 中接條組合  
(不可包鋼板)



面寬70

517 口字固定  
(不可包鋼板)



面寬60

2022



SHI TAI STEEL

THE INITY 2021 06



旭台浪板股份有限公司  
SHI TAI STEEL CO., LTD.