

CONTENTS

| | | | | |
|------------|--|--|--|-----|
| OA | 辦公資料樹德櫃系列 Office Filing Cabinets | | | 05 |
| SC | 多功能專業置物櫃系列 Chic Space Cabinets | SC 風格置物櫃 / O ₃ 臭氧科技鞋櫃 FC 密碼鎖置物櫃 DU 密碼鎖文件櫃 | | 21 |
| WB | 專業高荷重型工作桌/重型櫃系列 Ultra Heavy-duty Workbenches | WH 高荷重型 WM 中荷重型 WL 輕荷重型 | | 33 |
| ST | 專業零物件分類櫃系列 Steel Parts Cabinets | ST 零件櫃 MC 手機櫃 | | 49 |
| FO | 掀開式快取零物件分類盒 Quick Flip out Bins | FO 快取分類盒 RFO 快取盒旋轉架 MS-FO 快取分類車/背掛板系列 | | 57 |
| CT | 專業工具車系列 Ultra Heavy-duty Cart Series | CT 工具車 TC 專業工具車 TW 刀具車/刀具架/背掛板系列 | | 61 |
| HB | 耐衝擊分類置物整理盒 Ultra Stack & Hanging Bins | MS-HB 工業效率車 NHD 零件櫃效率車 RC 效率櫃/效率架 | | 67 |
| TB | 專業工具箱系列 Professional Tool Boxes | | | 73 |
| SH | 優雅生活輕辦公 Combination of Total Office Storage Solutions | MCA 曲木文件車 WT 和風書桌 SH 書架系列 | | 77 |
| DD | 文具辦公事務整理系列 Stationery Organisers | DD 桌上資料櫃 SB 方塊盒系列 OF 隨意盒 OA 公文分類盒 | | 83 |
| MB | 居家生活收納系列 Total storage solutions | MB 系統收納箱 NHA 置物箱 KD 巧拼收納箱 PC 玲瓏盒 CB 兒童收納系列 TB 生活手提箱 | | 87 |
| MTO | 接單生產 Make to Orders | 最低訂購量 請電洽客服專線 | 此標示為接單生產品 接單生產最少訂購量 MOQ 100 件 | 107 |

詳細資料備索，本目錄所載之規格，本公司保有變更之權利；商品之內容、尺寸、顏色如有不符，以實品為準。
All specifications subject to change without notice.

Trademarks used herein are the property of SHUTER Enterprise Co., Ltd. or of their respective owners.

OA
樹德櫃

SC
置物櫃

WB
工作桌

ST
零件櫃

FO
快取盒

CT
工具車

HB
整理盒

TB
工具箱

SH
輕辦公

DD
文具整理

MB
居家收納

MTO
接單生產

OA 資料效率樹德櫃與置物櫃系列 Office Filing Cabinets

樹德櫃 提升辦公效率的代名詞 讓樹德與高品質畫上等號的見證

樹德櫃一詞的由來

樹德企業創辦人吳景霖老師於1982年在台中研發製造了台灣第一座「樹德櫃」從此改變了台灣辦公室獨特的文件歸檔整理文化，創造出有別於歐美、東南亞區域的資料整理收納模式，在樹德櫃推出前，台灣尚未出現「平盤式」文件分類櫃，「樹德櫃」因而成為此類辦公文件櫃的泛稱通用詞之一，坊間所稱的資料櫃或效率櫃亦分別為樹德企業早期所命名並沿用至今。



100%

Original SHUTER filing cabinet

堆疊的文件 需要耐心
複雜的流程 需要簡化
浪費的時間 需要縮短
煩擾的心緒 需要放鬆
知道捷徑在哪裡 壓力 就沒有了



M-8040 (06-01)
800W x 400D x 400H mm



A4X-B316P (06-02)
800W x 400D x 400H mm



DU-8040 (06-03)
800W x 400D x 400H mm



■ 密碼鎖
Patent NO. D129666



■ 腳柱 (選購)
FT-10 (06-04)
60W x 60D x 105H mm



■ A4X-P抽
262W x 356D x 39.5H mm

OA
樹德櫃

SC
圖物櫃

WB
工作桌

ST
零件櫃

FO
快取盒

CT
工具車

HB
整理盒

TB
工具箱

SH
輕辦公

DD
文具整理

MB
居家收納

MTO
接單生產



鋅鐵合金10倍防鏽，30年耐用保證

雪白體驗，品味時尚

■ 樹德櫃 特色介紹



延長使用

採用鍍鋅鋼板，比一般鋼材，抗蝕多倍以上時間



耐用抗腐蝕

更耐銹、耐蝕，更能極大延長產品年限



30年耐用品質保證

產品烤漆使用高溫粉體塗裝處理，更環保
低環境影響

■ 櫃體鍍金介紹



樹德使用厚度達 **0.8mm**

高溫粉體塗裝
鍍鋅層
鋼材

VS

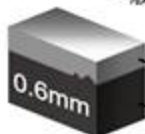

一般鋼板厚度 **<0.6mm**

烤漆
鋼材

■ 10倍防鏽 品質保證 一般環境下放置72小時，一般冷熱軋鋼板或黑皮板即產生鏽斑



鍍鋅合金鋼板

VS



一般金屬鋼板

▪ 選購配件 Optional Accessories



A4X B4V 落地型系列產品皆可加鎖
 [抽取式]透明視窗設計，提高搜尋文件效率
 當透明視窗取下後，還可以作為開放抽使用



A4XM2-4H2P2V (08-01)
 590W x 400D x 690H mm

▪ A4X B4V 可透視抽屜特色說明

Patent NO. M331330, M331910



下置把手設計，符合人體工學抽拉更省力



專利煞車設計，猛力拉出也不易脫落
 抽屜底部滑條設計，輕盈滑暢沒阻力



獨家特殊原料配方耐衝擊，
 掉落不易破碎

▪ A4X 可透視加大抽屜 262W x 356D x 39.5H mm



A4加大寬度可直放資料夾



A4加大寬度可直放一般雙孔列表紙

OA
樹德櫃

SC
置物櫃

WB
工作桌

ST
零件櫃

FO
快取盒

CT
工具車

HB
整理盒

TB
工具箱

SH
輕辦公

DD
文具整理

MB
居家收納

MTO
接單生產

樹德櫃抽屜尺寸表

⚠ 請參照各型號荷重限制載重勿超過荷重範圍 **kg** **L**

OA
樹德櫃

A4X Drawer Specifications

| 抽屜型號 | 外徑 (mm) | 內徑 (mm) | 安全荷重 | 容積 | 顏色 | 材質 |
|-------|---------------------|----------------------|------|-------|-------|---------|
| A4X-P | 262W x 356D x 39.5H | 256W x 335D x 36H | 2 kg | 3 L | 透明/雪白 | GPS/IPS |
| A4X-H | 262W x 358D x 81.5H | 256W x 335D x 78H | 4 kg | 6.6 L | 透明/雪白 | GPS/IPS |
| A4X-L | 262W x 360D x 167H | 256W x 335D x 163.5H | 8 kg | 14 L | 透明/雪白 | GPS/IPS |

SC
置物櫃

WB
工作桌

ST
零件櫃



A4X-P 標準抽 **2** **3**

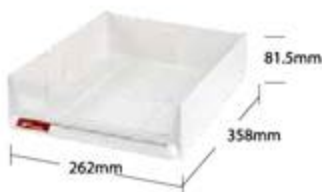

A4X-H 加高抽 **4** **6.6**



A4X-L 特大抽 **8** **14**

FO
快取盒

CT
工具箱

HB
整理盒

B4V

註：B4V 產品與 B4 不可混搭

| 抽屜型號 | 外徑 (mm) | 內徑 (mm) | 安全荷重 | 容積 | 顏色 | 材質 |
|-------|---------------------|-------------------|--------|-------|-------|---------|
| B4V-P | 270W x 404D x 39.5H | 265W x 382D x 36H | 3 kg | 3.6 L | 透明/雪白 | GPS/IPS |
| B4V-H | 270W x 406D x 81.5H | 265W x 382D x 78H | 5.5 kg | 7.8 L | 透明/雪白 | GPS/IPS |

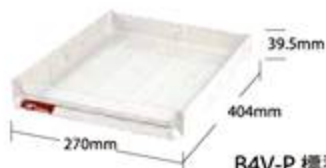

B4V-P 標準抽 **3** **3.6**

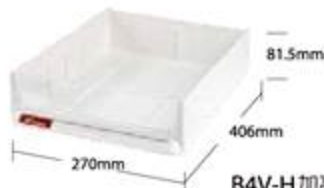

B4V-H 加高抽 **5.5** **7.8**

A4

| 抽屜型號 | 外徑 (mm) | 內徑 (mm) | 安全荷重 | 容積 | 顏色 | 材質 |
|------|---------------------|----------------------|------|--------|-------|---------|
| A4-P | 235W x 343D x 39.5H | 230W x 325D x 37H | 2 kg | 2.7 L | 透明/雪白 | GPS/IPS |
| A4-H | 235W x 343D x 81.5H | 230W x 325D x 79H | 4 kg | 5.9 L | 透明/雪白 | GPS/IPS |
| A4-L | 235W x 343D x 167H | 230W x 325D x 163.5H | 8 kg | 12.2 L | 透明/雪白 | GPS/IPS |
| A4-O | 235W x 343D x 39.5H | 230W x 328D x 37H | 2 kg | 2.8 L | 透明/雪白 | IPS |
| A4-S | 235W x 343D x 8H | 230W x 320D x 30H | 2 kg | | 透明/雪白 | IPS |

TB
工具箱

SH
輕辦公

DD
文具整理

MB
居家收納

MTO
接單生產

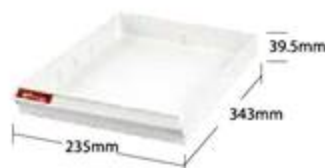

A4-P 標準抽 **2** **2.7**



A4-H 加高抽 **4** **5.9**



A4-L 特大抽 **8** **12.2**

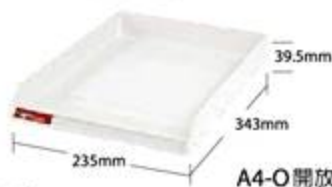

A4-O 開放抽 **2** **2.8**

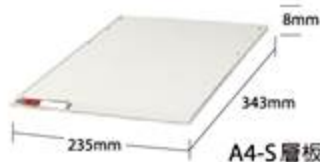

A4-S 層板抽 **2**

櫃體色系選擇 Body Color

米白/時尚灰 為接單生產品 **MOQ 030**



雪白



米白 **MOQ**



時尚灰 **MOQ**

樹德櫃選購配件 Accessory



腳柱

材質：特採1.2mm特殊鋼板

FT-10
60wx60Dx105Hmm



加鎖 請參考頁面 P.08

A4X B4V 全系列落地型產品
單排雙排三排櫃體皆可加鎖



水平調整腳

A4X抽690mm高
側櫃系列(皆附水平調整
腳一組)
可調到740mm與桌面同高
調整間距最多可達5cm。



加輪 DIY

本公司研發部於1993年研發之
滑輪組，獨特專利設計加裝組
合適用於所有樹德櫃與零件櫃
系列滑輪前面二只附有煞車裝
置，可隨時將活動櫃固定在適
當的位置。

W-4035 滑輪套件
(附扳手x2, 螺母x2, 滑輪x4)

Patent NO. 86487

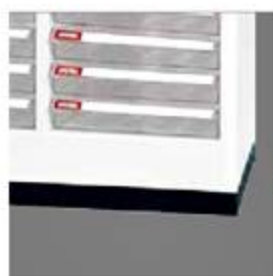

底座



底座規格

| 型號 | 樣式 | 尺寸/內徑 |
|----|------|-----------------------|
| A4 | 2排底座 | 540W x 340D x 50H mm |
| | 3排底座 | 795W x 340D x 50H mm |
| B4 | 2排底座 | 611W x 450D x 50H mm |
| | 3排底座 | 902W x 450D x 50H mm |
| A3 | 2排底座 | 710W x 439D x 50H mm |
| | 3排底座 | 1050W x 439D x 50H mm |



桌板



桌板規格

| 型號 | 樣式 | 尺寸/內徑 |
|----|------|-----------------------|
| A4 | 2排面板 | 545W x 340D x 18H mm |
| | 3排面板 | 795W x 340D x 18H mm |
| B4 | 2排面板 | 611W x 450D x 18H mm |
| | 3排面板 | 902W x 450D x 18H mm |
| A3 | 2排面板 | 710W x 439D x 18H mm |
| | 3排面板 | 1050W x 439D x 18H mm |

A3 Drawer Specifications

MOQ 產品請參考接單生產頁面 P.106

| 抽屜型號 | 外徑 (mm) | 內徑 (mm) | 安全荷重 | 容積 | 顏色 | 材質 |
|------|-------------------|---------------------|--------|--------|-------|---------|
| A3-P | 320W x 446D x 39H | 313W x 425D x 36.5H | 3.5 kg | 4.7 L | 透明/雪白 | GPS/IPS |
| A3-H | 320W x 446D x 82H | 313W x 425D x 80H | 7 kg | 10.6 L | 透明/雪白 | GPS/IPS |

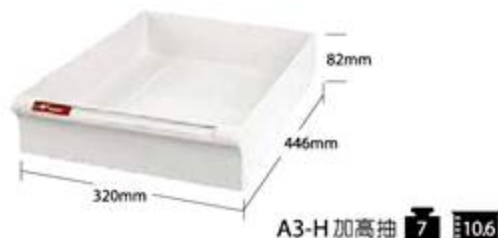
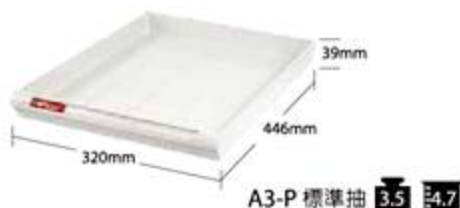

B4

註: B4V 產品與 B4 不可混搭

MOQ 產品請參考接單生產頁面 P.107

| 抽屜型號 | 外徑 (mm) | 內徑 (mm) | 安全荷重 | 容積 | 顏色 | 材質 |
|------|-------------------|-------------------|------|-------|-------|---------|
| B4-F | 270W x 404D x 48H | 265W x 386D x 45H | 3 kg | 4.6L | 透明/雪白 | GPS/IPS |
| B4-O | 270W x 405D x 40H | 265W x 382D x 38H | 3 kg | 2.8 L | 雪白 | IPS |
| B4-S | 270W x 405D x 8H | 265W x 382D x 30H | 3 kg | | 雪白 | IPS |

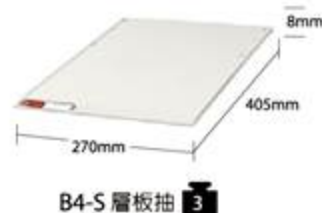
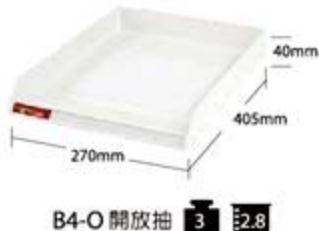
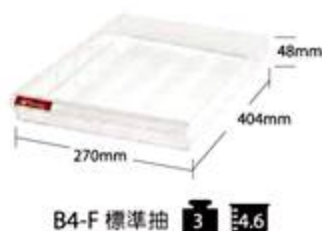

A4, B4 抽屜型式

層板抽的距離
以38mm等距任意拉高



A4, B4 抽屜變化示意

在同一個櫃子，有五種不同的抽屜變化，特定搭配組合，滿足您的需求。



MT 掀開式雜誌櫃系列 Magazine Cabinets

寬90公分深40公分與理想櫃搭配，完美組合您辦公室的所有櫃體。



M-2S (12-01)
900W x 450D x 740H mm



過期刊物

當期雜誌

M-3S (12-02)
900W x 450D x 1062H mm

■ 樹德櫃抽屜變化說明 1個L抽高度，等於2個H抽高度，等於4個P抽高度



- 同一個櫃子裡，有不同抽屜的變化，您可以任意搭配組合，能滿足您的所有需求
一次訂購10台樹德櫃產品，抽屜可依客戶需求調整組合變化，需7天交期

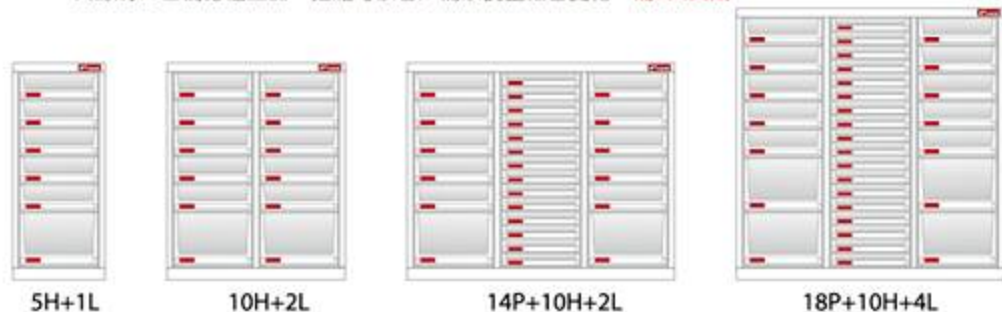

- ▲ 抽屜正確拉取方式應由抽屜下方把手位置拉取，若其他方式拉取易造成視窗破裂損壞，請使用正確方式拉取讓抽屜壽命更長久。



A4 樹德櫃系列
Desktop Filing Cabinet Series

抽屜可選用高透明抽屜或耐衝擊雪白抽屜



透明抽屜(P)

雪白抽屜(N)

A4X 桌上型樹德櫃系列 Desktop Filing Cabinet Series

高度=44cm



A4X-108PK (14-01)
304W x 400D x 440H mm



A4XM1-4H1P (14-02)
304W x 400D x 440H mm



A4X-218P (14-03)
590W x 400D x 440H mm



A4XM2-8H2P (14-04)
590W x 400D x 440H mm



MOQ 030
A4X-109P2V (14-05)
590W x 400D x 440H mm



MOQ 030
A4XM1-4H1P2V (14-06)
590W x 400D x 440H mm

A4X 與三尺文件櫃搭配的樹德櫃系列

寬度=88cm 高度=44cm



V-5V (14-07)
880W x 400D x 440H mm



A4X-327P (14-08)
880W x 400D x 440H mm



A4XM3-12H3P (14-09)
880W x 400D x 440H mm

A4 桌上型樹德櫃系列

⚠️ 抽屜可選用高透明抽屜或耐衝擊雪白抽屜



A4-103P (14-10)
264W x 343D x 199H mm



A4-104K (14-11)
264W x 343D x 297H mm



A4-105P (14-12)
264W x 343D x 287H mm



A4-106P (14-13)
264W x 343D x 287H mm



A4-105H (14-14)
285W x 343D x 483H mm



A4-110P (14-15)
285W x 343D x 483H mm



A4-106H (14-16)
285W x 343D x 574H mm



A4-112P (14-17)
285W x 343D x 574H mm



A4-B209 (14-18)
535W x 343D x 440H mm



A4-220P (14-19)
535W x 343D x 483H mm



A4-210H (14-20)
535W x 343D x 483H mm

OA
樹德櫃

SC
置物櫃

WB
工作桌

ST
零件櫃

FO
快取盒

CT
工具車

HB
整理盒

TB
工具箱

SH
輕辦公

DD
文具整理

MB
居家收納

MTO
接單生產



OA 辦公樹德櫃系列 Office Filing Cabinets

A4X 落地型樹德櫃系列 Floor Type Cabinet Series



■ 側櫃系列加購桌面板，可當側桌使用



■ 側櫃未加桌面板亦可直接當側桌或放置於桌底下

水平調整腳

A4X抽69cm高
側櫃系列(皆附水平調整腳一組)
可調到74cm與桌面同高
調整間距最多可達5cm。



■ 側櫃系列附調整腳 可由69~74cm自由調整高度

A4X 樹德櫃側櫃系列 Side Cabinet Series

高度=69cm



A4X-114PK (16-01)
304W x 400D x 690H mm



A4X-107HK (16-02)
304W x 400D x 690H mm



A4X-228PK (16-03)
590W x 400D x 690H mm



A4X-214HK (16-04)
590W x 400D x 690H mm



A4X-210P3V (16-05)
590W x 400D x 690H mm



A4XM2-101-3V (16-06)
590W x 400D x 690H mm



A4X-342PK (16-07)
880W x 400D x 690H mm



A4X-321HK (16-08)
880W x 400D x 690H mm



A4X-315P5V (16-09)
880W x 400D x 690H mm



A4XM3-6H3P5V (16-10)
880W x 400D x 690H mm

A4X 樹德櫃搭配列表機小特助系列 Filling Cabinet Combined with Printers Series

高度=69cm



A4XM2-4H2P2V (16-11)
590W x 400D x 690H mm



A4XM3-6H3P3V (16-12)
880W x 400D x 690H mm

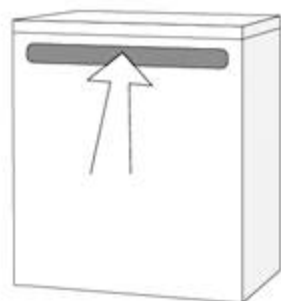

櫃體後設計貼心開口
報表紙及列印紙可由此進出!

OA
樹德櫃

SC
置物櫃

WB
工作桌

ST
零件櫃

FO
快取盒

CT
工具箱

HB
整理盒

TB
工具箱

SH
輕辦公

DD
文具整理

MB
居家收納

MTO
接單生產

A4X 落地型樹德櫃系列 Floor Type Cabinet Series

高度=88cm

OA
樹德櫃

SC
置物櫃

WB
工作桌

ST
零件櫃

FO
快取盒

CT
工具車

HB
整理盒

TB
工具箱

SH
輕辦公

DD
文具整理

MB
居家收納

MTO
接單生產



A4X-118PK (17-01)
304W x 400D x 880H mm



A4X-109HK (17-02)
304W x 400D x 880H mm



A4X-236PK (17-03)
A4X-236PD 加門型 (17-04)
590W x 400D x 880H mm



A4X-218HK (17-05)
A4X-218HD 加門型 (17-06)
590W x 400D x 880H mm



A4X-236PD



A4X-218HD



A4X-218PK3V (17-07)
590W x 400D x 880H mm



A4XM2-121K-3V (17-08)
590W x 400D x 880H mm

樹德櫃 加門型附鎖系列 Filing Cabinet with Lockable & Doors

 附鎖加門，對開門設計不佔空間
文件管理更便利



A4X-354PK (17-09)
880W x 400D x 880H mm



A4XM3-18H18P (17-10)
880W x 400D x 880H mm



A4X-327HK (17-11)
880W x 400D x 880H mm



A4X-354PD (17-12) 
880W x 400D x 880H mm



A4X-327HD (17-13) 
880W x 400D x 880H mm

A4 落地型樹德櫃系列

 抽屜可選用高透明抽屜或耐衝擊雪白抽屜



A4-115P (18-01)
285W x 343D x 740H mm



A4M1-7x1 (18-02)
285W x 343D x 740H mm



A4-118P (18-03)
285W x 343D x 880H mm



A4-109H (18-04)
285W x 343D x 880H mm



A4-230P (18-05)
545W x 343D x 740H mm



A4M2-14x2 (18-06)
545W x 343D x 740H mm



A4-236P (18-07)
545W x 343D x 880H mm



A4-218H (18-08)
545W x 343D x 880H mm



A4-345P (18-09)
800W x 343D x 740H mm



A4M3-21x3 (18-10)
800W x 343D x 740H mm



A4-354P (18-11)
800W x 343D x 880H mm



A4-327H (18-12)
800W x 343D x 880H mm



A4-366P (18-13)
800W x 343D x 1062H mm



A4-333H (18-14)
800W x 343D x 1062H mm



A4-132P (18-15)
285W x 343D x 1490H mm

MOQ 030



A4-116H (18-16)
285W x 343D x 1490H mm

MOQ 030

OA
樹德櫃

SC
置物櫃

WB
工作桌

ST
零件櫃

FO
快取盒

CT
工具車

HB
整理盒

TB
工具箱

SH
輕辦公

DD
文具整理

MB
居家收納

MTO
接單生產

B4V 桌上型樹德櫃系列 抽屜說明請參考頁面 P.09**B4V-103P** (19-01)
300W x 400D x 210H mm**B4V-106P** (19-02)
300W x 400D x 297H mm**B4V-103H** (19-03)
300W x 400D x 297H mm**B4V-105P** (19-04)
300W x 400D x 297H mm**B4V-110P** (19-05)
311W x 400D x 483H mm**B4V-105H** (19-06)
311W x 400D x 483H mm**B4V-112P** (19-07)
311W x 400D x 574H mm**B4V-106H** (19-08)
311W x 400D x 574H mm**B4V 與理想櫃搭配的樹德櫃系列**

高度=41cm

**B4V-B316P** (19-09)
900W x 450D x 410H mm**B4V-B308H** (19-10)
900W x 450D x 410H mm**B4V 樹德櫃系列**

高度=74cm

**B4V-115P** (19-11)
321W x 450D x 740H mm**B4VM1-7X1** (19-12)
321W x 450D x 740H mm**B4V-230P** (19-13)
613W x 450D x 740H mm**B4VM2-14X2** (19-14)
613W x 450D x 740H mm**B4V-345P** (19-15)
900W x 450D x 740H mm**B4VM3-21X3** (19-16)
900W x 450D x 740H mm

B4V 樹德櫃系列 抽屜說明請參考頁面 P.09

高度=106.2 / 149 cm



B4V-122P (20-01)
321W x 450D x 1062H mm



B4V-111H (20-02)
321W x 450D x 1062H mm



B4V-244P (20-03)
613W x 450D x 1062H mm



B4V-222H (20-04)
613W x 450D x 1062H mm



B4V-366P (20-05)
900W x 450D x 1062H mm



B4V-333H (20-06)
900W x 450D x 1062H mm



B4V-116H (20-07)
321W x 400D x 1490H mm



B4V-132P (20-08)
321W x 400D x 1490H mm

B4F 樹德櫃系列 MOQ 030 抽屜說明請參考頁面 P.10



B4-110F (20-09)
321W x 450D x 580H mm



B4-10F3P (20-10)
321W x 450D x 740H mm



B4M2-20F6P (20-11)
611W x 450D x 740H mm



B4M3-30F9P (20-12)
900W x 450D x 740H mm



B4M1-15F4P (20-13)
321W x 450D x 1062H mm



B4M2-30F8P (20-14)
611W x 450D x 1062H mm



B4M3-45F12P (20-15)
900W x 450D x 1062H mm

OA
樹德櫃

SC
置物櫃

WB
工作桌

ST
零件櫃

FO
快取盒

CT
工具車

HB
整理盒

TB
工具箱

SH
輕辦公

DD
文具整理

MB
居家收納

MTO
接單生產

SC 風格置物櫃臭氧科技鞋櫃

Space Cabinets & Stylish Design with O₃ Technology

創新設計 體驗科技

塑膠結構與門板搭配金屬櫃體，是複合材質的完美結合。
全新無橫樑垂柱，現代簡約設計。



雪白櫃體/腳柱 **MOQ 030**
SCM3-1M4SA (21-01)
890W x 350D x 502H mm

風格置物櫃特色說明 Characteristics of Chic Space Cabinet

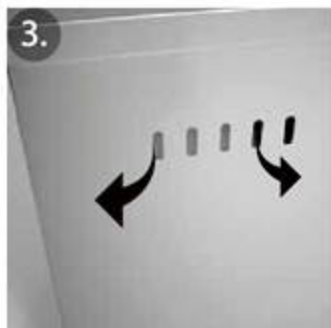
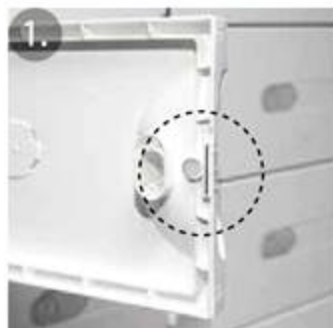

1. 門片開關採用強力磁鐵吸附，容易開關(附緩衝墊)
2. 人性機能設計，門片內部，均有3個掛鉤，可掛鑰匙或小物件
3. 櫃體背部，通氣孔設計，減少異味
4. 專利門片結構設計，更加堅固耐用，門片組裝拆修便利
5. 門片均附彈力繩可放置信件帳單小物收納

Patent NO. M258653 D105635

M 門片

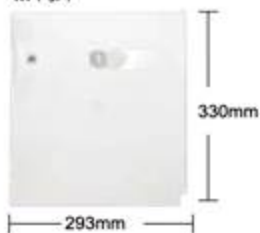

S 門片

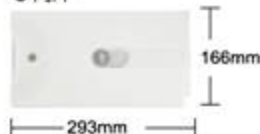

風格置物櫃選購配件 Accessory



臭氧機規格：

輸入電壓 DC12V
輸入電流 300mA below
臭氧濃度 15ppm± 15%
臭氧機尺寸
50W x 30D x 40H mm



木質坐墊

材質：MDF+木紋貼皮

WP-3 (22-01)
892W x 350D x 15H mm

WP-4 (22-02)
1187.5W x 350D x 15H mm



門片加鎖

每片門片附2支鑰匙



腳柱

材質：特採1.2mm特殊鋼板

FT-10 (22-03)
60W x 60D x 105H mm

H=100mm

門片顏色 Door Color 材質：IPS特殊耐衝擊塑膠面板



粉綠



粉藍



雪白

OA
樹德櫃

SC
置物櫃

WB
工作桌

ST
零件櫃

FO
快取盒

CT
工具車

HB
整理盒

TB
工具箱

SH
輕辦公

DD
文具整理

MB
居家收納

MTO
接單生產

SC 風格置物櫃 Chic Cabinets / 臭氧科技鞋櫃 Stylish Design with O₃ Technology
寬度=89cm

OA 樹德櫃

SC 置物櫃

WB 工作桌

ST 零件櫃

FO 快取盒

CT 工具車

HB 整理盒

TB 工具箱

SH 輕辦公

DD 文具整理

MB 居家收納

MTO 接單生產



SC-306A (23-01)
890W x 350D x 502H mm



SCM3-1M4S (23-02)
890W x 350D x 387H mm



SC-303M (23-03)
890W x 350D x 387H mm



SC-309S (23-04)
890W x 350D x 550H mm



SCM3-1M7S (23-05)
890W x 350D x 550H mm



SCM3-3M3S (23-06)
890W x 350D x 550H mm



SC-312S (23-07)
890W x 350D x 714H mm



SCM3-3M6S (23-08)
890W x 350D x 714H mm



SC-306M (23-09)
890W x 350D x 714H mm



SC-315S (23-10)
890W x 350D x 880H mm



SC-318S (23-11)
890W x 350D x 1040H mm

SC 風格置物櫃 Chic Cabinets / 臭氧科技鞋櫃 Stylish Design with O₃ Technology
寬度=119cm



SC-408A (23-12)
1190W x 350D x 502H mm



SC-416S (23-13)
1190W x 350D x 714H mm



SC-420S (23-14)
1190W x 350D x 880H mm

SC 風格置物櫃 Chic Cabinets / **臭氧科技鞋櫃** Stylish Design with O₃ Technology
 寬度=119cm



SCM4-4M12S (24-01)
1190w x 350D x 880H mm



SCM4-8M4S (24-02)
1190w x 350D x 880H mm



SC-424S (24-03)
1190w x 350D x 1040H mm



SCM4-8M8S (24-04)
1190w x 350D x 1040H mm



SC-412M (24-05)
1190w x 350D x 1040H mm

SC 風格置物櫃 Chic Cabinets



SC-101M (24-06)
300w x 352D x 365H mm



KD結構設計堅固耐用，組裝便利



產品可上下堆疊，任意組合



OA
樹德櫃

SC
置物櫃

WB
工作桌

ST
零件櫃

FO
快取盒

CT
工具車

HB
整理盒

TB
工具箱

SH
輕辦公

DD
文具整理

MB
居家收納

MTO
接單生產

FC 密碼鎖置物櫃 Keyless Lockers

Patent NO. D129666

心中的鑰匙不易遺失，使用管理皆便利



■ 特色說明 Features



密碼鎖



層板/掛衣桿

L=295mm
≈ 19.1mm 3/4 inch



透氣孔



內附標示卡，管理更便利

■ 配件 Accessories



1

腳墊/高低可調



2

萬用鑰匙(管理者)



3

標示卡



4

密碼設定說明



5

密碼設定卡(管理者)

櫃體型式搭配門片組合

鍍金門板-鍍鋅鋼板**10**倍防鏽、**30**年耐用保證



FC 系列
寬=90cm / 高=89.5cm
900W x 510D x 895H mm

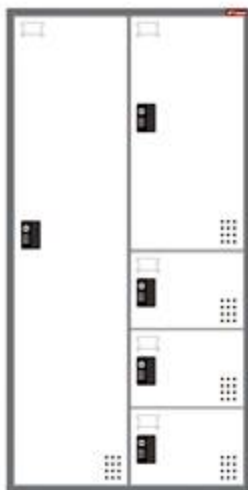

FC1-2 系列
寬=90cm / 高=180cm
900W x 510D x 1800H mm

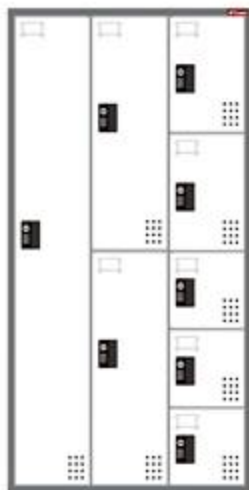

FC1-3 系列
寬=90cm / 高=180cm
900W x 510D x 1800H mm

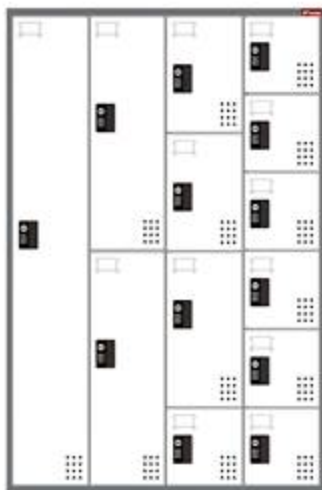

FC1-4 系列
寬=118.2cm / 高=180cm
1182 W x 510D x 1800H mm

門片型式

FC1-2 系列門片

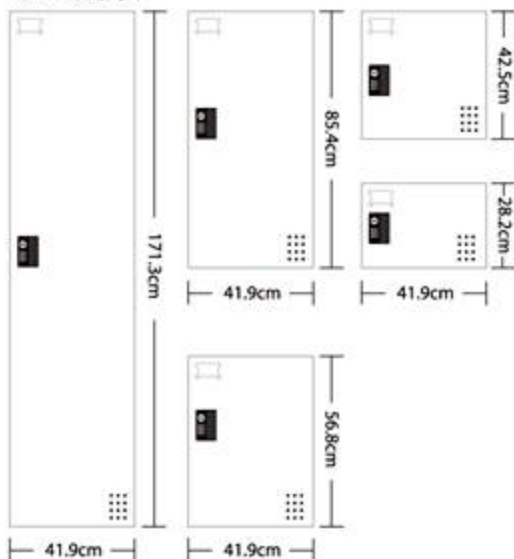

FC1-3/FC1-4 系列門片

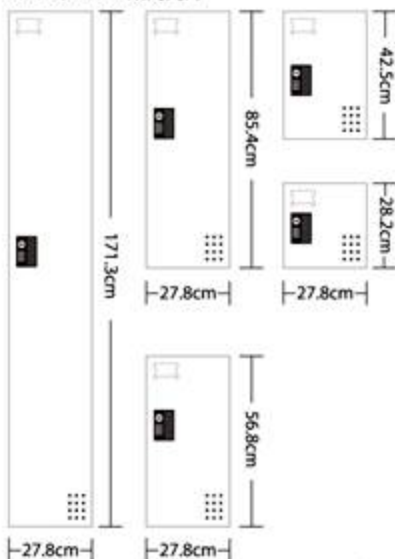

OA
樹德櫃

FC
置物櫃

WB
工作桌

ST
零件櫃

FO
快取盒

CT
工具車

HB
整理盒

TB
工具箱

SH
輕辦公

DD
文具整理

MB
居家收納

MTO
接單生產

FC 密碼鎖置物櫃 Keyless Lockers

Multi-functional Digital Lockers are Easy to Reset the Pass Code

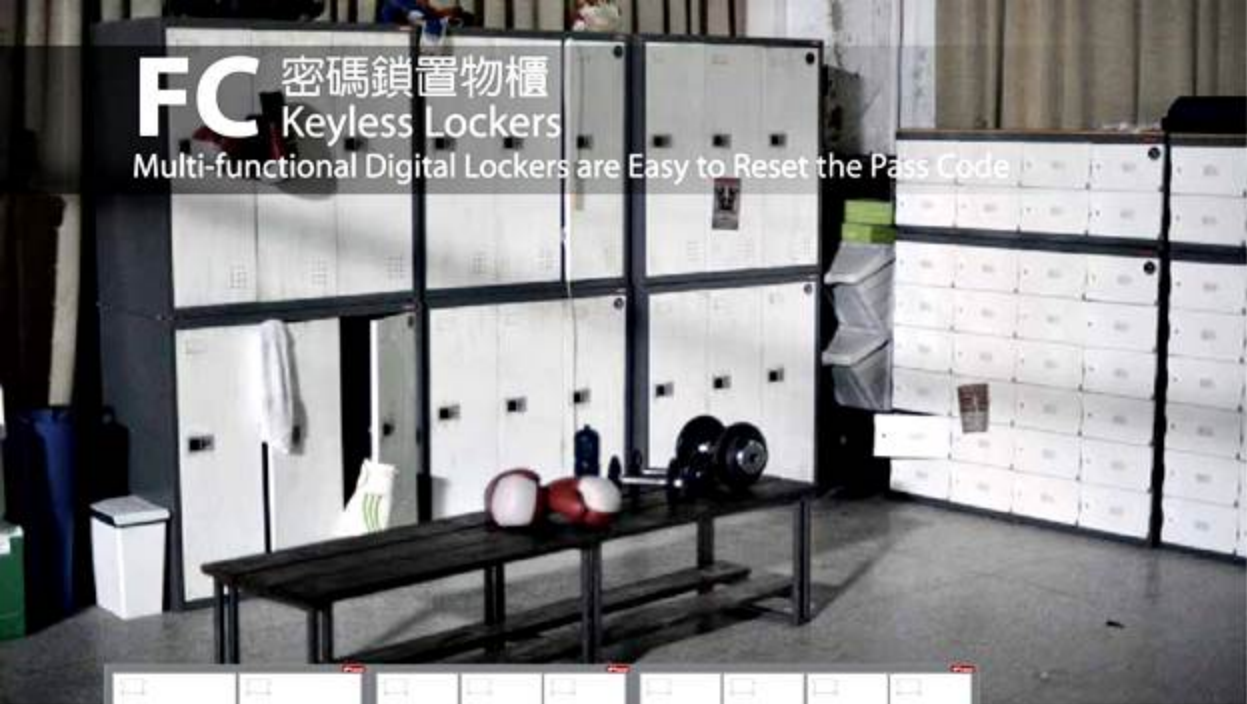

FC 置物櫃**90cm**寬

高度=**89.5cm**



FC-309 (27-01)
900W x 510D x 895H mm



FC-306 (27-02)
900W x 510D x 895H mm



FC-303 (27-03)
900W x 510D x 895H mm

FC 置物櫃 90cm寬 2排門

高度=180 cm

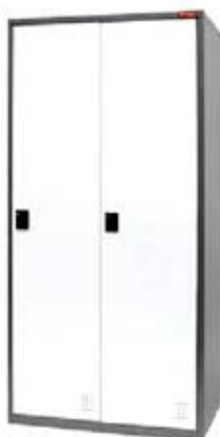

FC1-202 (28-01)
900W x 510D x 1800H mm

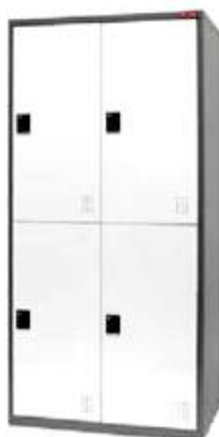

FC1-204 (28-02)
900W x 510D x 1800H mm

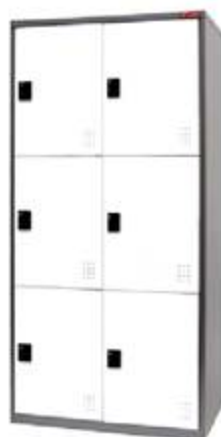

FC1-206 (28-03)
900W x 510D x 1800H mm



FC1-208 (28-04)
900W x 510D x 1800H mm



FC1-212 (28-05)
900W x 510D x 1800H mm

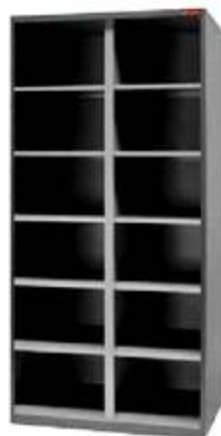

FCO-212 (28-06)
900W x 510D x 1800H mm

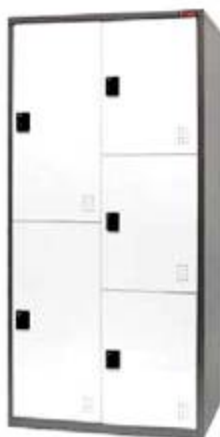

FC1-M205 (28-07)
900W x 510D x 1800H mm



FC1-M207 (28-08)
900W x 510D x 1800H mm



FC1-M210 (28-09)
900W x 510D x 1800H mm

OA
樹德櫃

FC
置物櫃

WB
工作桌

ST
零件櫃

FO
快取盒

CT
工具車

HB
整理盒

TB
工具箱

SH
輕辦公

DD
文具整理

MB
居家收納

MTO
接單生產

FC 置物櫃 90cm寬 3排門

高度=180 cm

OA 樹德櫃

FC 置物櫃

WB 工作桌

ST 零件櫃

FO 快取盒

CT 工具車

HB 整理盒

TB 工具箱

SH 輕辦公

DD 文具整理

MB 居家收納

MTO 接單生產



FC1-303 (29-01)
900W x 510D x 1800H mm

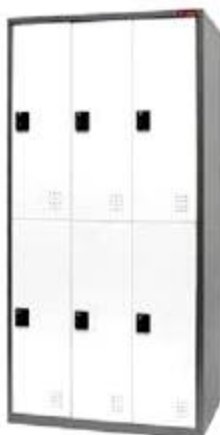

FC1-306 (29-02)
900W x 510D x 1800H mm



FC1-309 (29-03)
900W x 510D x 1800H mm



FC1-312 (29-04)
900W x 510D x 1800H mm

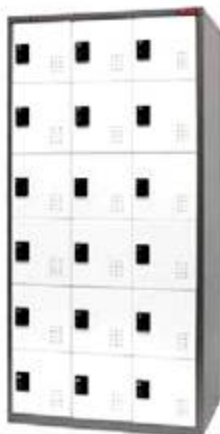

FC1-318 (29-05)
900W x 510D x 1800H mm

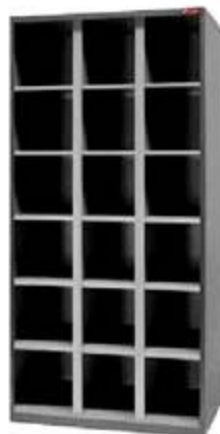

FCO-318 (29-06)
900W x 510D x 1800H mm



FC1M-309 (29-07)
900W x 510D x 1800H mm

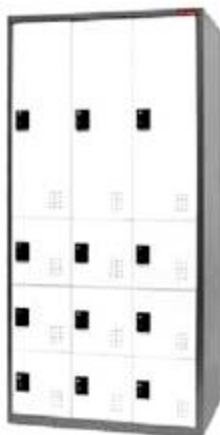

FC1M-312 (29-08)
900W x 510D x 1800H mm

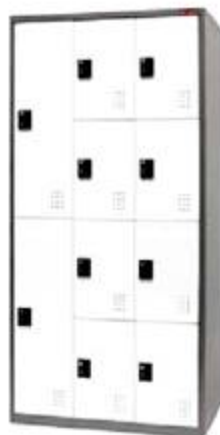

FC1M-310 (29-09)
900W x 510D x 1800H mm

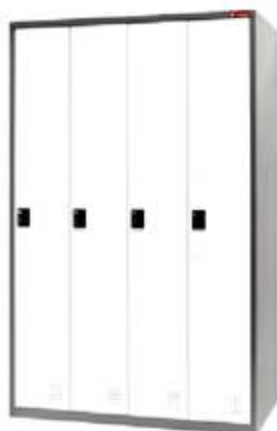

FC1-404 (30-01)
1182W x 510D x 1800H mm

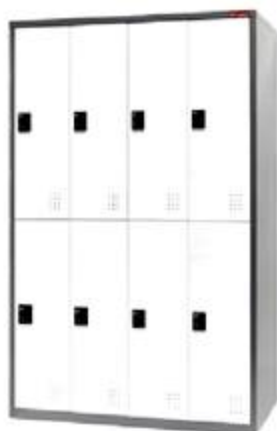

FC1-408 (30-02)
1182W x 510D x 1800H mm

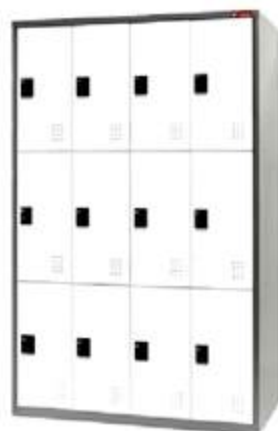

FC1-412 (30-03)
1182W x 510D x 1800H mm

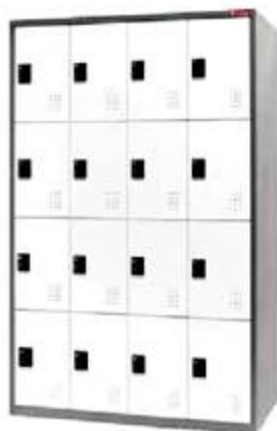

FC1-416 (30-04)
1182W x 510D x 1800H mm

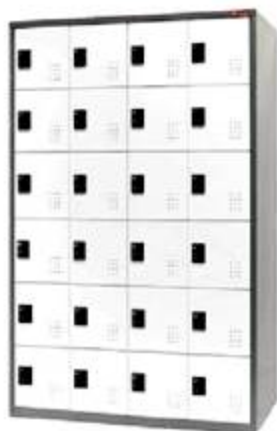

FC1-424 (30-05)
1182W x 510D x 1800H mm



FCO-424 (30-06)
1182W x 510D x 1800H mm



FC1M-412 (30-07)
1182W x 510D x 1800H mm

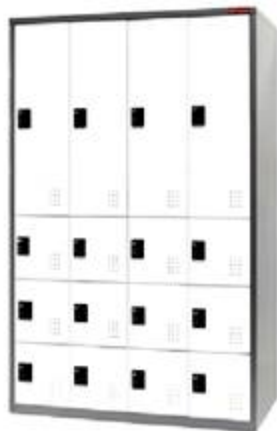

FC1M-416 (30-08)
1182W x 510D x 1800H mm

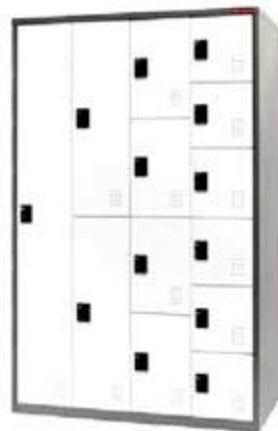

FC1M-413 (30-09)
1182W x 510D x 1800H mm

OA
樹德櫃

FC
置物櫃

WB
工作桌

ST
零件櫃

FO
快取盒

CT
工具車

HB
整理盒

TB
工具箱

SH
輕辦公

DD
文具整理

MB
居家收納

MTO
接單生產

DU 密碼鎖文件櫃 Digital Lock Filing Cabinet

Patent NO. D129666

全國首創 文件櫃搭配密碼鎖 改善鑰匙保管的不便

心中的鑰匙不易遺失,方便取用



■ 特色說明 Features



密碼鎖



內附標示卡, 管理更便利

■ 鋼製櫃體

厚度: **0.8mm**

材質: **0.7mm**日本進口Alloy特殊防鏽鍍鋅鋼板

0.1mm高溫粉體塗裝, 長時間使用不易生鏽



DU-315P (31-01)

880W x 400D x 795H mm

FT-10 (31-02)

60W x 60D x 105H mm

■ 配件 Accessories



1 DU-315P 無此配件
鋼製層板



2 DU-315P 無此配件
層板固定扣



3 書檔



4 鎖匙



5 標示卡

櫃體顏色 Body color

專屬烤漆，配合企業識別顏色，增加整體感
 最低訂購量 **30** 台，製作交期 **30** 工作天
 時尚鐵灰烤漆櫃體 為接單生產品 **MOQ 030**

櫃體建議安全荷重約：**100kgs**
 層板安全荷重約：**30kgs**



DU 密碼鎖文件四尺櫃**118cm**寬

高度=88 cm



DU-118G (32-01)
1180w x 400D x 880H mm



DU-118M (32-02)
1180w x 400D x 880H mm



DU-11809M (32-03)
1180w x 400D x 880H mm

DU 密碼鎖文件三尺櫃**88cm**寬

高度=88 cm



DU-88G (32-04)
880w x 400D x 880H mm



DU-88M (32-05)
880w x 400D x 880H mm



DU-8809M (32-06)
880w x 400D x 880H mm

OA
樹德櫃

DU
密碼櫃

WB
工作桌

ST
零件櫃

FO
快取盒

CT
工具車

HB
整理盒

TB
工具箱

SH
輕辦公

DD
文具整理

MB
居家收納

MTO
接單生產



工作桌的頂級選擇 兼顧安全 效率 荷重三大使用保證

多種材質專業桌面選配 Choose Worktop Material & Select The Suitable Peg Boards

| 桌板(代號) | 桌面種類 | 2100mm | 1800mm | 1500mm |
|--|----------------------------------|--|--|--|
|  (M) | 耐磨桌面 WH7M,WH6M,WH5M, 系列使用 | WT-7M (33-01) 2100W x 750D x 52H mm | WT-6M (33-02) 1800W x 750D x 52H mm | WT-5M (33-03) 1500W x 750D x 52H mm |
|  (U) | 耐衝擊桌面 WH7U,WH6U,WH5U, 系列使用 | WT-7U (33-04) 2100W x 750D x 52H mm | WT-6U (33-05) 1800W x 750D x 52H mm | WT-5U (33-06) 1500W x 750D x 52H mm |
|  (S) | 不鏽鋼桌面 WH7S,WH6S,WH5S, 系列使用 | WT-7S (33-07) 2100W x 750D x 52H mm | WT-6S (33-08) 1800W x 750D x 52H mm | WT-5S (33-09) 1500W x 750D x 52H mm |
|  (I) | 鋼製桌面 WH6I,WH5I 系列使用 | | WT-6I (33-10) 1800W x 750D x 60H mm | WT-5I (33-11) 1500W x 750D x 60H mm |
|  (W) | 原木桌面 WH7W,WH6W,WH5W 系列使用 | WT-7W (33-12) 2100W x 750D x 50H mm | WT-6W (33-13) 1800W x 750D x 50H mm | WT-5W (33-14) 1500W x 750D x 50H mm |
|  (T) | 高密度桌面 WH7T,WH6T,WH5T 系列使用 | WT-7T (33-15) 2100W x 750D x 56H mm | WT-6T (33-16) 1800W x 750D x 56H mm | WT-5T (33-17) 1500W x 750D x 56H mm |
|  (M) | 耐磨桌面 WM系列使用 WL系列使用 | | | WT-5MM (33-18) 1500W x 750D x 32H mm WT-5ML (33-19) 1500W x 750D x 32H mm |

桌面說明 Features 建議安全荷重 loading capacity



高荷重



可裝虎鉗



防水



耐油



耐酸鹼



耐高溫



耐磨













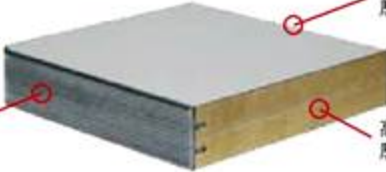

耐衝擊

■ 桌面特殊尺寸可接受訂製

■ 耐高溫-桌板表面180°C

■ 耐磨-測試轉速800轉/分

■ 耐衝擊-

| 桌板種類 | 桌面材質說明 | 材質特性 |
|-----------------------|---|---|
| (M) 耐磨桌面 | <p>▲ 2000kg 4409.2 lb</p>  <p>PVC封邊膠條</p> <p>高壓美耐板(耐磨層) 厚度=0.8mm</p> <p>高壓纖維板(HDF) 厚度=50mm</p> |  <p>適合一般電子作業，研究實驗，檢測工作，醫療院所與職業學校作業環境。</p> |
| (U) 耐衝擊桌面 | <p>▲ 2000kg 4409.2 lb</p>  <p>PVC封邊膠條</p> <p>合成膠面(耐衝擊層) 厚度=2mm</p> <p>高壓纖維板(HDF) 厚度=50mm</p> |  <p>適合一般作業使用，機具維護，維修工作，生產線組裝與高荷重型工作環境。</p> |
| (S) 不鏽鋼桌面 | <p>▲ 2000kg 4409.2 lb</p>  <p>#304不鏽鋼桌面 厚度=1.2mm</p> <p>高壓纖維板(HDF) 厚度=50mm</p> |  <p>適合一般作業使用，無塵工作環境，食品加工，實驗檢測工作，醫療院所電子作業環境。</p> |
| (I) 鋼製桌面+耐衝擊桌墊 | <p>▲ 1000kg 2204.6 lb</p>  <p>鍍鋅鋼板 厚度=2mm</p> <p>耐衝擊合成膠桌墊 厚度=14mm</p> <p>高溫粉體烤漆</p> |  <p>適合各行業使用，組裝作業，保養廠，維修廠作業環境。</p> |
| (W) 原木桌面 | <p>▲ 1000kg 2204.6 lb</p>  <p>表面防護塗漆層</p> <p>松木集成木板 厚度=54mm</p> |  <p>適合一般作業使用，木工作業，精密維修，檢測作業環境。 原木桌面耐高溫為80°C</p> |
| (T) 專業級高密度多工桌板 | <p>▲ 2000kg 4409.2 lb</p>  <p>PVC封邊膠條</p> <p>高密度板 厚度=5-6mm</p> <p>高壓纖維板(HDF) 厚度=50mm</p> |  <p>適合各行業使用，模具業，鉗工業維修廠，重型工作環境。</p> |

OA 樹德櫃

SC 置物櫃

WB 工作桌

ST 零件櫃

FO 快取盒

CT 工具車

HB 整理盒

TB 工具箱

SH 輕辦公

DD 文具整理

MB 居家收納

MTO 捲單生產



耐磨桌面



耐衝擊桌面



不鏽鋼桌面



原木桌面



樹德強化桌面



耐衝擊桌墊

WH5I,WH6I 系列專用

工作桌特色說明 Features



K/D設計
組裝容易



附調整腳座
水平調整功能



鋼板厚度為
2mm



耐刮烤漆
10倍防鏽



SGS專業測試
高荷重承載能力



建議安全荷重
平均承載



結構專利

工作桌

尺寸說明

適用環境/特性

重型工作桌

WH7M (35-01)
2100w x 750D x 800H mm

2000kg
4409.2 (lbs)

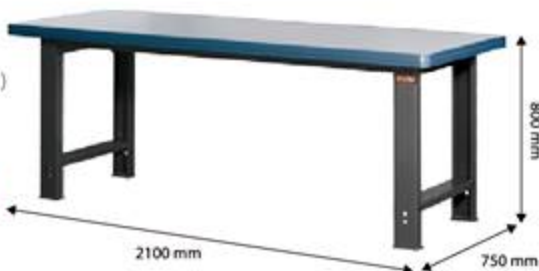

M 耐磨桌面
高荷重、耐油、耐磨
耐酸鹼。

工作桌可選購搭配組合
各式掛板組、燈組、電器盒
抽屜、吊櫃、重型櫃。
WH7M 產品組合
請參考頁面 **P.37**

WH6M (35-02)
1800W x 750D x 800H mm

2000kg
4409.2 (lbs)



M 耐磨桌面
高荷重、耐油、耐磨
耐酸鹼。

工作桌可選購搭配組合
各式掛板組、燈組、電器盒
抽屜、吊櫃、重型櫃。
WH6M 產品組合
請參考頁面 **P.38**

WH5M (35-03)
1500W x 750D x 800H mm

2000kg
4409.2 (lbs)



M 耐磨桌面
高荷重、耐油、耐磨
耐酸鹼。

工作桌可選購搭配組合
各式掛板組、燈組、電器盒
抽屜、吊櫃、重型櫃。
WH5M 產品組合
請參考頁面 **P.38**

重型鋼製工作桌

WH6I (36-01)

1800W x 750D x 800H mm

KG 1000kg

2204.6 (lbs)



耐衝撞桌墊
耐衝擊、高荷重
耐油、耐磨。

工作桌可選購搭配組合
各式掛板組、燈組、電器盒
抽屜、吊櫃、重型櫃。
WH6I 產品組合
請參考頁面 **P.39**

重型鋼製工作桌

WH5I (36-02)

1500W x 750D x 800H mm

KG 1000kg

2204.6 (lbs)



耐衝撞桌墊
耐衝擊、高荷重
耐油、耐磨。

工作桌可選購搭配組合
各式掛板組、燈組、電器盒
抽屜、吊櫃、重型櫃。
WH6I 產品組合
請參考頁面 **P.40**

中型工作桌

WM5M (36-03)

1500W x 750D x 800H mm

KG 600kg

1322.8 (lbs)



耐磨桌面
高荷重、耐油、耐磨
耐酸鹼。

工作桌可選購搭配組合
各式掛板組、燈組、電器盒
抽屜、吊櫃、重型櫃。
WH7M 產品組合
請參考頁面 **P.40**

輕型工作桌

WL5M (36-04)

1500W x 750D x 800H mm

KG 100kg

220.46 (lbs)



耐磨桌面
高荷重、耐油、耐磨
耐酸鹼。

工作桌可選購搭配組合
各式掛板組、燈組、電器盒
抽屜、吊櫃、重型櫃。
WH7M 產品組合
請參考頁面 **P.41**

高度可調型工作桌

AM5M (36-05)

1500W x 750D x 600~1000H mm

KG 600kg

1322.8 (lbs)



耐磨桌面
高荷重、耐油、耐磨
耐酸鹼。

打造適合您的工作桌組合

選擇最適合您工作內容的桌面材質以及掛鉤組合，大幅擴充工作桌功能。

OA
樹德櫃

SC
置物櫃

WB
工作桌

ST
零件櫃

FO
快取盒

CT
工具車

HB
整理盒

TB
工具箱

SH
輕辦公

DD
文具整理

MB
居家收納

MTO
接單生產

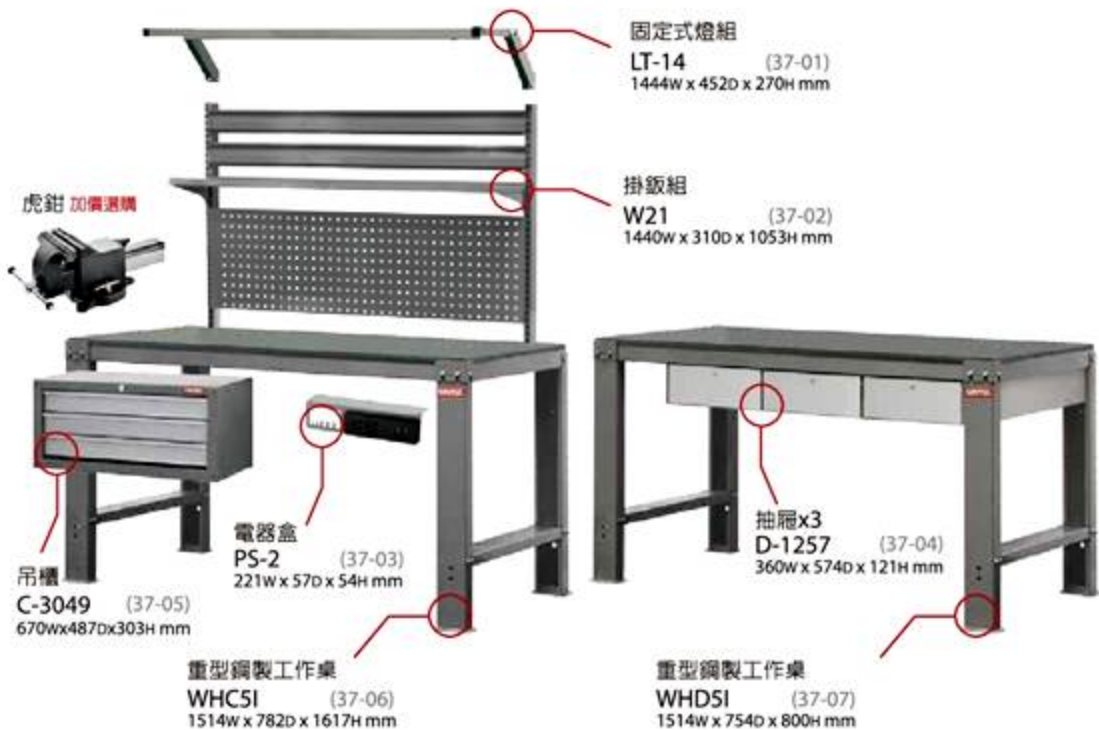

選配說明 Additional selections

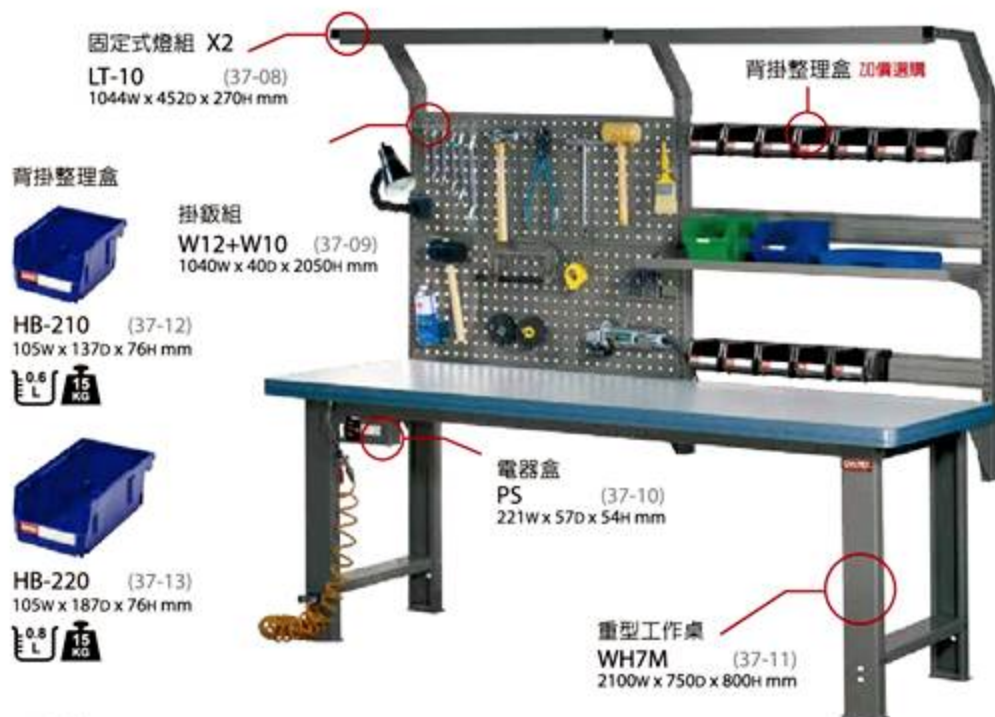

工作桌選配表 Composition of Workbenches

| | WH7M | WH6M/WH6I | WH5M/WH5I | WM,WL |
|---|--|---|--|---|
| 掛板組 Square-shape perforated plate set | | | | |
|  | W10 (38-01) 1040wx310dx1053H mm | W40 (38-02) IW40 for WH6I (38-03) 890wx310dx1053H mm | W20 (38-04) IW20 for WH5I (38-05) 1440wx310dx1053H mm | W30 (38-06) 1240wx310dx1053H mm |
|  | W11 (38-07) 1040wx310dx1053H mm | W41 (38-08) IW41 for WH6I (38-09) 890wx310dx1053H mm | W21 (38-10) IW21 for WH5I (38-11) 1440wx310dx1053H mm | W31 (38-12) 1240wx310dx1053H mm |
|  | W12 (38-13) 1040wx40dx1053H mm | W42 (38-14) IW42 for WH6I (38-15) 890wx40dx1053H mm | W22 (38-16) IW22 for WH5I (38-17) 1440wx40dx1053H mm | W32 (38-18) 1240wx40dx1053H mm |
| 方孔掛板 Square-shape-perforated platet | | | | |
|  | HP-10-8 (38-19) 1000wx20dx400H mm | HP-08-8 (38-20) 851wx20dx400H mm | HP-14-8 (38-21) 1400wx20dx400H mm | HP-12-8 (38-22) 1200wx20dx400H mm |
| 層板 Flat-hanger plate set | | | | |
|  | HP-10-72 (38-23) 1007wx280dx37.8H mm | HP-08-72 (38-24) 858wx280dx37.8H mm | HP-14-72 (38-25) 1407wx280dx37.8H mm | HP-12-72 (38-26) 1207wx280dx37.8H mm |
| 單架式掛板 Rack | | | | |
|  | HP-10-5 (38-27) 1000wx22.2dx97H mm | HP-08-5 (38-28) 895wx22.2dx97H mm | HP-14-5 (38-29) 1400wx22.2dx97H mm | HP-12-5 (38-30) 1200wx22.2dx97H mm |
| 固定式燈組 Lighting set 燈具規格:TS省電燈組,低反光不刺眼 | | | | |
|  | LT-10 (38-31) 1044wx452dx270H mm | LT-08 (38-32) 895wx452dx270H mm | LT-14 (38-33) 1444wx452dx270H mm | LT-12 (38-34) 1244wx452dx270H mm |
| 固定式燈組 Lighting set 燈具規格:LED省電燈組,低反光不刺眼 | | | | |
|  | LED-10 (38-35) 1044wx452dx270H mm | LED-08 (38-36) 895wx452dx270H mm | LED-14 (38-37) 1444wx452dx270H mm | LED-12 (38-38) 1244wx452dx270H mm |
| 吊櫃 Hanging drawer | | 抽屜 Drawer | | |
|  | C-3049 (38-39) 670wx487dx303H mm KG 抽屜每層荷重 34 kg |  | D-1257 (38-40) 360wx574dx121H mm KG 抽屜每層荷重 50 kg | |
| 電器盒 Power outlet with safety device | | | | |
|  | PS (38-41) 223wx77dx83H mm 規格:無熔絲10A斷路器 電源限使用110V |  | PS-2 (38-42) 221wx57dx54H mm 規格:USB output DC 5V 2.1A 電源限使用110V | |
| 置物板 Steel plate set | | | | |
|  | WH(6M,5M) HC-5(中層板) (38-43) 1098wx600dx30H mm HP-5(下層板) (38-44) 1303wx498dx75H mm | WH6I HC-6I(中層板) (38-45) 1617wx594dx30H mm HP-6I(下層板) (38-46) 1820wx650dx75H mm | WH5I HC-5I(中層板) (38-47) 1310wx564dx30H mm HP-5I(下層板) (38-48) 1513wx650dx75 H mm | |

OA 樹德櫃

SC 置物櫃

WB 工作桌

ST 零件櫃

FO 快取盒

CT 工具車

HB 整理盒

TB 工具箱

SH 輕辦公

DD 文具整理

MB 居家收納

MTO 接單生產

工作桌特色說明 Features

K/D設計
組裝容易耐調整腳座
水平調整功能鋼板厚度為
2mm耐刮烤漆
10倍防鏽SGS專業測試
高荷重承載能力建議安全荷重
平均承載

結構專利

WH7M 高荷重型工作桌 210cm 寬

桌面材質說明請參考P.32

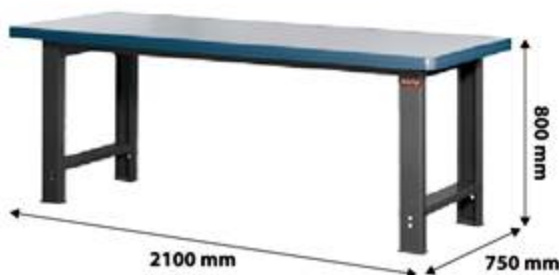

標準桌板

建議荷重



耐磨桌面

2000kg

4409.2 (lbs)

可選配專業桌板



耐衝擊桌面



不鏽鋼桌面



原木桌面



樹德強化桌面

WH7M (39-01)
2100W x 750D x 800H mmWHC7M (39-02)
2100W x 750D x 800H mmWHD7M (39-03)
2100W x 750D x 800H mmWH7M+W1010 (39-04)
2100W x 780D x 1630H mmWH7M+W1111 (39-05)
2100W x 780D x 1630H mmWH7M+W1212 (39-06)
2100W x 780D x 1630H mm

WH6M 高荷重型工作桌 180cm 寬

桌面材質說明請參考P.32



標準桌板

建議荷重



耐磨桌面

2000kg

4409.2 (lbs)

可選配專業桌板



耐衝擊桌面



不鏽鋼桌面



原木桌面



樹德強化桌面



WH6M (40-01)
1800W x 750D x 800H mm



WHC6M (40-02)
1800W x 750D x 800H mm



WHD6M (40-03)
1800W x 750D x 800H mm



WH6M+W20 (40-04)
1800W x 780D x 1630H mm



WH6M+W22 (40-05)
1800W x 780D x 1630H mm



WH6M+W22 (40-06)
1800W x 780D x 1630H mm

WH5M 高荷重型工作桌 150cm 寬

桌面材質說明請參考P.32



標準桌板

建議荷重



耐磨桌面

2000kg

4409.2 (lbs)

可選配專業桌板



耐衝擊桌面



不鏽鋼桌面



原木桌面



樹德強化桌面



WH5M (40-07)
1500W x 750D x 800H mm



WHC5M (40-08)
1500W x 750D x 800H mm



WHD5M (40-09)
1500W x 750D x 800H mm



WH5M+W20 (40-10)
1500W x 780D x 1630H mm



WH5M+W21 (40-11)
1500W x 780D x 1630H mm



WH5M+W22 (40-12)
1500W x 780D x 1630H mm

OA 樹德櫃

SC 置物櫃

WB 工作桌

ST 零件櫃

FO 快取盒

CT 工具車

HB 整理盒

TB 工具箱

SH 輕辦公

DD 文具整理

MB 居家收納

MTO 培華生產

OA
樹德櫃SC
置物櫃WB
工作桌ST
零件櫃FO
快取盒CT
工具車HB
整理盒TB
工具箱SH
輕辦公DD
文具整理MB
居家收納MTO
接單生產**WH6I 高荷重型鋼製工作桌 180cm 寬**

桌面材質說明請參考P.32



標準桌板

建議荷重

(I)

耐衝撞桌墊

1000kg

2204.6 (lbs)

WH6I (41-01)
1815W x 754D x 800H mmWHC6I (41-02)
1815W x 754D x 800H mmWHD6I (41-03)
1815W x 754D x 800H mmWH6I+W4040 (41-04)
1815W x 784D x 1617H mmWH6I+W4141 (41-05)
1815W x 784D x 1617H mmWH6I+W4242 (41-06)
1815W x 784D x 1617H mm**WH5I 高荷重型鋼製工作桌 150cm 寬**

桌面材質說明請參考P.32



標準桌板

建議荷重

(I)

耐衝撞桌墊

1000kg

2204.6 (lbs)

WH5I (41-07)
1510W x 754D x 800H mmWHC5I (41-08)
1510W x 754D x 800H mmWHD5I (41-09)
1510W x 754D x 800H mm

WH5I 高荷重型鋼製工作桌 150cm 寬

桌面材質說明請參考P.32



WH5I+W20 (42-01)
1510W x 784D x 1617H mm



WH5I+W21 (42-02)
1510W x 784D x 1617H mm



WH5I+W22 (42-03)
1510W x 784D x 1617H mm

WM 中荷重型工作桌 150cm 寬

桌面材質說明請參考P.32



1500 mm

800 mm

750 mm

標準桌板

建議荷重

(M)

600kg

耐磨桌面

1322.8 (lbs)

可選配專業桌板



耐衝擊桌面

原木桌面



WM5M (42-04)
1500W x 750D x 800H mm



WMD5M (42-05)
1500W x 750D x 800H mm



WM5M+W30 (42-06)
1500W x 780D x 1608H mm



WM5M+W31 (42-07)
1500W x 780D x 1608H mm



WM5M+W32 (42-08)
1500W x 780D x 1608H mm

OA 樹德櫃

SC 置物櫃

WB 工作桌

ST 零件櫃

FO 快取盒

CT 工具車

HB 整理盒

TB 工具箱

SH 輕辦公

DD 文具整理

MB 居家收納

MTO 接單生產

OA
樹德櫃

SC
置物櫃

WB
工作桌

ST
零件櫃

FO
快取盒

CT
工具車

HB
整理盒

TB
工具箱

SH
輕辦公

DD
文具整理

MB
居家收納

MTO
接單生產

WL 輕荷重型工作桌 150cm 寬

桌面材質說明請參考P.32



標準桌板

建議荷重



100kg

耐磨桌面

220.46 (lbs)

可選配專業桌板 加價選購



耐衝擊桌面



原木桌面



WL5M (43-01)
1500W x 750D x 800H mm

WL5M+W30 (43-02)
1500W x 780D x 1608H mm

WL5M+W31 (43-03)
1500W x 780D x 1608H mm

WL5M+W32 (43-04)
1500W x 780D x 1608H mm



重型櫃
HDC-0751
547Wx600Dx700H mm

原木重型櫃工作桌

WHM5W-51+W21+LT-14+HDC-0751
1500W x 750D x 1617H mm (43-05)



吊櫃
C-3049
670Wx487Dx303H mm

樹德強化板吊櫃工作桌

WHC5T+W21+LT-14+PS-2
1500W x 750D x 1617H mm (43-06)



工作桌配件表 Accessories for Workbenches

OA
樹德櫃

SC
置物櫃

WB
工作桌

ST
零件櫃

FO
快取盒

CT
工具車

HB
整理盒

TB
工具箱

SH
輕辦公

DD
文具整理

MB
居家收納

MTO
接單生產

斜角單鉤 L-shape hook 可吊掛 \varnothing 6mm 圓孔以上的工具安全荷重 5kg

| | | | |
|---|---|---|---|
| <p>HK-1110 D=100 mm (44-01) 10入/包</p> | <p>HK-1114 D=140 mm (44-02) 10入/包</p> | <p>HK-1119 D=190 mm (44-03) 10入/包</p> | <p>HK-1208 D=80 mm 直角掛鉤 (44-04) 10入/包</p> |
|---|---|---|---|

直角雙掛鉤 Double L-shape hook 可吊掛 \varnothing 6mm 圓孔以上的工具, T型工具, 安全荷重 10kg

| | | |
|--|--|---|
| <p>HK-2105 W=35 mm D=50 mm (44-05) 10入/包</p> | <p>HK-2108 W=35 mm D=80 mm (44-06) 10入/包</p> | <p>HK-2115 W=35 mm D=150 mm (44-07) 10入/包</p> |
|--|--|---|

大圓鉤 Double L-shape hook 圓罐托架 DouBottle holder

| | | |
|--|--|--|
| <p>HK-3160 \varnothing 62 mm (44-08) 2入/包</p> <p>可掛T型工具, 可放電動工具類, 安全荷重 10kg</p> | <p>HK-3175 \varnothing 75 mm (44-09) 2入/包</p> | <p>HK-6107 \varnothing 70 mm H=70 mm (44-10) 1入/包</p> <p>可放直徑70mm罐型物品</p> |
|--|--|--|

扳手架 Expansion tool hanger 起子架 Screwdriver holder

| | |
|--|---|
| <p>HK-4114 (44-11) 124w x 140D x 50H mm 1入/包</p> <p>可放一組(8支)扳手</p> | <p>HK-5239 W=396 mm (44-12) 1入/包</p> <p>可放12支螺絲起子</p> |
|--|---|

彈片夾 Spring clip hook 鑽頭架 Drill holder

| | | |
|---|---|--|
| <p>HK-8110 \varnothing 9 mm D=28 mm (44-13) 10入/包</p> <p>可夾直徑 \varnothing 10~14 mm 工具</p> | <p>HK-8112 \varnothing 13 mm D=38 mm (44-14) 10入/包</p> | <p>HK-5120 W=200 mm (44-15) 1入/包</p> <p>可放 \varnothing 3~16.5 mm 工具</p> |
|---|---|--|

虎鉗 Vise

選購商品



- 鑄鋼虎鉗 4" (44-16)
夾口寬=10.16cm
- 鑄鋼虎鉗 5" (44-17)
夾口寬=12.7cm
- 鑄鋼虎鉗 6" (44-18)
夾口寬=15.24cm
- 鑄鋼虎鉗 8" (44-19)
夾口寬=20.32cm



HDC/MDC 專業高荷重型/中荷重型 Tool Cabinet Heavy Duty 工具櫃系列



高效率工作空間的提升關鍵 超過30年的極限品質 耐用見證

▪ 特色說明 Features



高荷重滑軌



整腳座可
水平調整



可選配
耐重輪



抽屜內附
隔板/槽片



耐刮烤漆
10倍防鏽



建議安全荷重
平均承載



結構專利



SGS專業測試
高荷重承載能力

▪ 型號辨識說明 Model Identification Note

HDC-07 51C+W50

重型櫃“H”

加輪組

背掛組合

櫃體高度代碼

07 = 700 mm

10 = 1000 mm

12 = 1200 mm

MDC-10 71T

中型櫃“M”

抽屜數

櫃體高度代碼

10 = 1000 mm

T 複式滑軌抽屜

200kg

抽屜安全荷重

中型櫃滑軌

50kg

抽屜安全荷重

重型櫃滑軌

100kg

抽屜安全荷重

■ 抽屜規格說明 Features

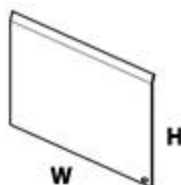
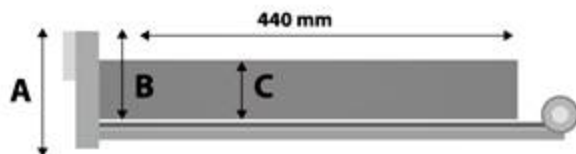

■ 抽屜槽隔板規格說明

工具櫃抽屜尺寸表

(mm)

| A | B | C |
|-----|-----|-----|
| 75 | 58 | 50 |
| 100 | 83 | 75 |
| 150 | 133 | 125 |
| 200 | 183 | 125 |

抽屜槽隔板尺寸表

(mm)

| 型號 | 適用抽屜高度 | 尺寸 |
|-------|---------|-----------|
| IB-3S | 75 | 140Wx43H |
| IB-4S | 100 | 140Wx68H |
| IB-6S | 150/200 | 140Wx118H |
| IB-6L | 150/200 | 214Wx118H |

- 4種抽屜高度搭配櫃體組合，抽屜高75 / 100 / 150 / 200 mm
- 單式滑軌每抽荷重100kg，中荷重型工具櫃每抽荷重50kg
- 複式滑軌(T)抽屜荷重200kg，可100%全開
- 抽屜使用1.2mm冷軋鋼板，經磷酸鹽處理後再粉體烤漆防銹效果佳
- 第一抽屜附分類盒其餘抽屜附隔板與槽片組合運用配置適當分隔空間
- 抽屜四周設有隔槽，可配合槽隔板及隔板作適當分隔空間
- 抽屜滑軌使用3mm鋼板，並配合軸承滑動順暢

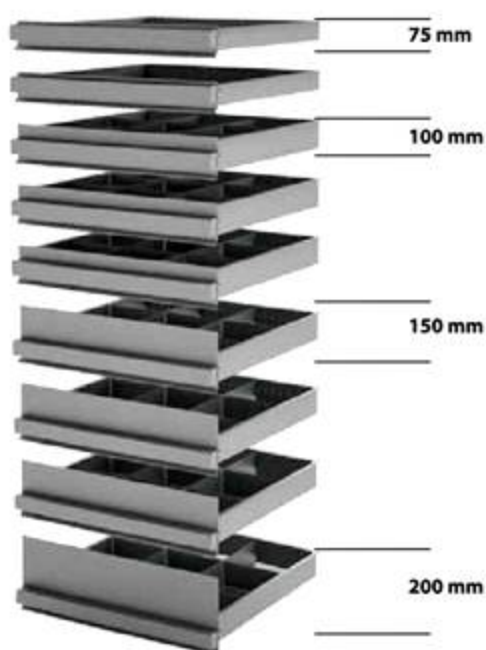
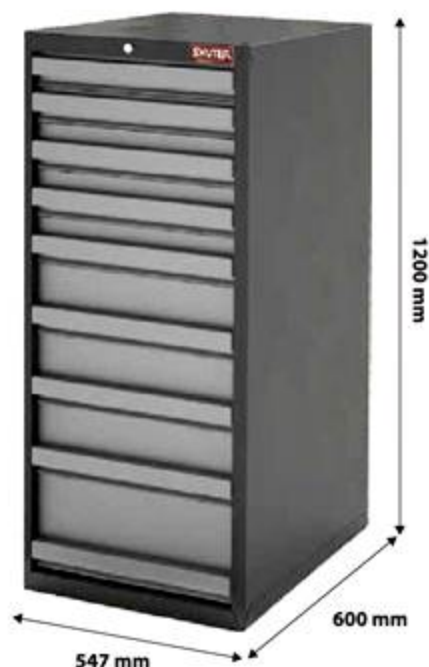

OA
樹德櫃

SC
圖物櫃

HDC
重型櫃

ST
零件櫃

FO
快取盒

CT
工具車

HB
整理盒

TB
工具箱

SH
輕辦公

DD
文具整理

MB
居家收納

MTO
接單生產

重型工具櫃特色 Features

OA
樹德櫃

SC
置物櫃

HDC
重型櫃

ST
零件櫃

FO
快取盒

CT
工具車

HB
整理盒

TB
工具箱

SH
輕辦公

DD
文具整理

MB
居家收納

MTO
接單生產



- 3款櫃體高 700 / 1000 / 1200 mm
- 櫃體底部附有水平調整腳，保護櫃體及調整水平
- 連桿式鎖具上鎖及抽屜全部上鎖
- 把手耐安全扣，未經開啓不會滑出掉落
- 櫃體四周導角，無銳角提升安全及防撞功能
- 抽屜把手外緣與櫃體平整
- 可選複式滑軌(T)抽屜荷重200kg，可100%全開



▲ 選購 複式滑軌，產品型號後+(T)

HDC 高荷重型工具櫃

高度=120cm

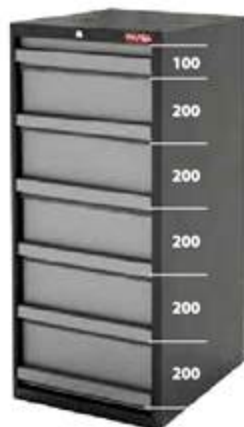

HT-1261 (47-01)
547W x 600D x 1200H mm

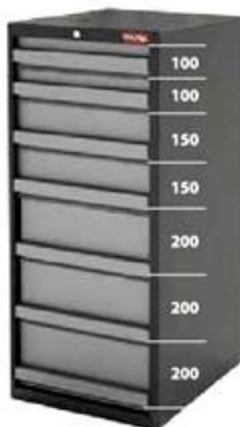

HT-1271 (47-02)
547W x 600D x 1200H mm

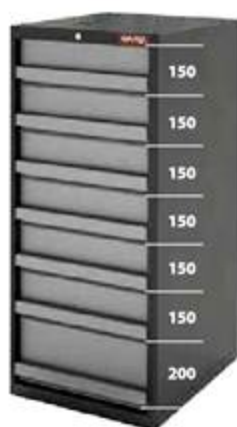

HT-1272 (47-03)
547W x 600D x 1200H mm

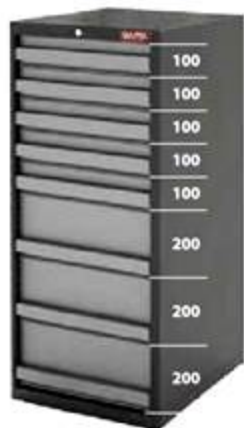

HT-1281 (47-04)
547W x 600D x 1200H mm

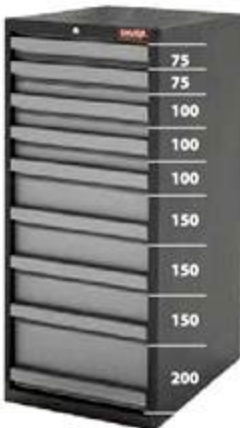

HT-1291 (47-05)
547W x 600D x 1200H mm

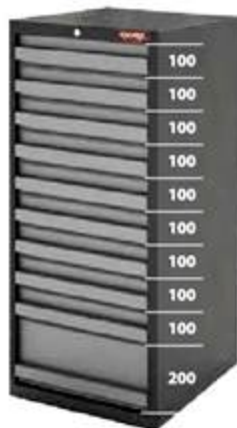

HT-1210 (47-06)
547W x 600D x 1200H mm

MDC / MDC 高荷重型/中荷重型工具櫃

高度=100cm



HDC-1051 (48-01)
MDC-1051 (48-02)
547W x 600D x 1000H mm



HDC-1061 (48-03)
MDC-1061 (48-04)
547W x 600D x 1000H mm



HDC-1062 (48-05)
547W x 600D x 1000H mm



HDC-1071 (48-06)
MDC-1071 (48-07)
547W x 600D x 1000H mm

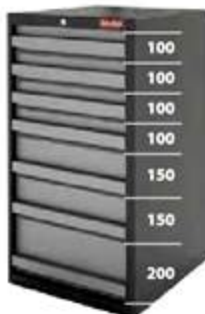

HDC-1072 (48-08)
547W x 600D x 1000H mm

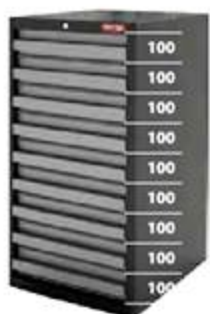

HDC-1091 (48-09)
MDC-1091 (48-10)
547W x 600D x 1000H mm

HDC / MDC 高荷重型/中荷重型工具櫃

高度=70cm



HDC-0741 (48-11)
MDC-0741 (48-12)
547W x 600D x 700H mm



HDC-0742 (48-13)
547W x 600D x 700H mm



HDC-0751 (48-14)
MDC-0751 (48-15)
547W x 600D x 700H mm



HDC-0752 (48-16)
MDC-0752 (48-17)
547W x 600D x 700H mm



HDC-0761 (48-18)
MDC-0761 (48-19)
547W x 600D x 700H mm



HDC-0771 (48-20)
547W x 600D x 700H mm

OA
樹德櫃

SC
置物櫃

HDC
重型櫃

ST
零件櫃

FO
快取盒

CT
工具車

HB
整理盒

TB
工具箱

SH
輕辦公

DD
文具整理

MB
居家收納

MTO
接單生產

ST 專業零物件分類櫃系列

Steel Parts Cabinets



耐重軌道



高承重櫃體



SGS測試



嚴的標準



專利抽屜



可抽取視窗



附隔板



抗油焚蝕

SHUTER
practical working attitude

整理收納是效率捷徑

直覺的透視每個分類，直接的拿取需要的零件
是節省時間又方便管理的唯一答案。

零件分類櫃系列說明 Features

鋼製櫃體 Frame

材質: **0.8mm** 日本進口Alloy特殊防鏽鍍鉍鋼板
 規格: **0.7mm** 鍍鉍鋼板
 烤漆: **0.1mm** 高溫粉體塗裝, 耐磨抗刮, 長時間使用不易生鏽

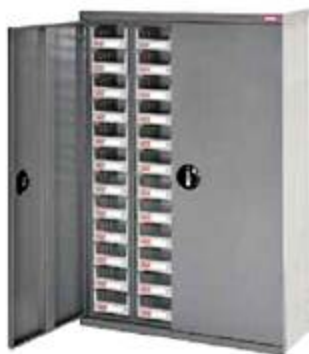

櫃體護套 Cabinet Jacket

三角護套保護櫃體, 使用更安全 (隨櫃附贈)



抽屜 Drawer

抽屜: **PS**透明視窗
ABS耐油抽屜

內附隔板, 空間靈活運用多變化。
 軌道使用塑膠POM材質, 耐重易抽拉。



對開式附鎖加門設計 Split Design with Lock & Portal

對開門較不占空間, 使用比單開門便利



ABS

耐油耐衝, 抗油腐蝕, 耐重力衝擊可取代傳統鐵抽。

丙烯腈-丁二烯-苯乙烯
 Acrylonitrile Butadiene Styrene



PS

高透明抽屜, 方便辨識管理。

聚苯乙烯 Polystyrene

活動底座 Mobile Base

落地型零件櫃, 均可加裝活動底座
 底座活動輪兩前輪煞車裝置, 可安全將零件櫃固定在適合位置



建議安全荷重 loading capacity **300kg**

W-6045 (50-01)
 596W x 454D x 160H mm
 A7-448x2 ST1-575x2
 A8-560x2 ST2-460x2

W-8941 (50-02)
 890W x 410D x 185H mm
 HD-530



OA 樹德櫃

SC 置物櫃

WB 工作桌

ST 零件櫃

FO 快取盒

CT 工具箱

HB 整理盒

TB 工具箱

SH 輕辦公

DD 文具整理

MB 居家收納

MTO 接單生產

NHD/HD 耐重抽系列

| 抽屜型號 | 尺寸(mm) | 尺寸(inch) | 材質 | 容量 | 安全荷重 |
|---------|----------------|--------------------|--------|------|------|
| HD-1641 | 164Wx375Dx105H | 6.4"Wx14.7"Dx4.1"H | ABS/PS | 5.6L | 20Kg |

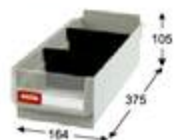

- 全新ABS加長型耐油耐衝擊抽屜，搭配PS專利透明前視窗
- 穩致安全防掉落抽屜，強力煞車不落地
- 耐重櫃體平均荷重**300kg**



9抽



15抽



18抽



30抽

HD-309 (51-01)
550W x 400D x 440H mm

HD-515 (51-02)
880W x 400D x 440H mm

HD-318 (51-03)
550W x 400D x 880H mm

HD-530 (51-04)
880W x 400D x 880H mm

HHD系列-KD櫃體設計



NHD-560 可調式層板
NHD-530 含把手及活動輪組



+

=



NHD-530 (51-06)
880W x 400D x 1010H mm

NHD-560 (51-05)
880W x 400D x 1725H mm

MOQ 030

樹德櫃/時尚灰為接單生產品

活動底座

建議安全荷重 loading capacity **300kg**



W-8941 (51-07)
890W x 410D x 185H mm



880mm

400mm



880mm

400mm



附特製耐撞隔板可依
需求調整隔間變化



全開抽屜設計，取物方便
安全卡榫，開啓不易掉落



尺寸與樹德櫃相同方便
層疊空間運用自如



層板使用熱浸鍍鋅鋼板
抗腐蝕、抗氧化、耐摩擦

A5V 大容量抽系列

| 抽屜型號 | 尺寸(mm) | 尺寸(inch) | 材質 | 容量 | 安全荷重 |
|------------|---------------|--------------------|--------|------|------|
| A5V drawer | 163Wx289Dx69H | 6.4"Wx11.3"Dx2.7"H | ABS/PS | 2.9L | 10Kg |



- 全新ABS加長型耐油耐衝擊抽屜，搭配PS專利透明前視窗
- 極致安全防掉落抽屜，強力煞車不落地
- 耐重櫃體平均荷重**300kg**



A5V-312 (52-01)
586W x 290D x 350H mm



A5V-324 (52-02)
586W x 290D x 640H mm



A5V-336 (52-03)
586W x 290D x 937H mm
A5V-336D (52-04) 加門型
586W x 340D x 970H mm

A6V/A6 大容量抽系列

| 抽屜型號 | 尺寸(mm) | 尺寸(inch) | 材質 | 容量 | 安全荷重 |
|------------|---------------|-------------------|--------|------|----------|
| A6V drawer | 150Wx248Dx83H | 5.9"Wx9.7"Dx3.2"H | ABS/PS | 2.6L | 10Kg |
| A6P drawer | 150Wx248Dx40H | 5.9"Wx9.7"Dx1.5"H | ABS/PS | 1.3L | 10Kg/6kg |

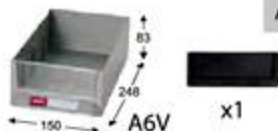

- 全新ABS加長型耐油耐衝擊抽屜，搭配PS專利透明前視窗-A6V抽
- 極致安全防掉落抽屜，強力煞車不落地
- 耐重櫃體平均荷重**300kg**

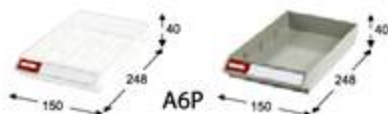

A6V-309 (52-05)
533W x 265D x 310H mm



A6-318P (52-06)
533W x 265D x 310H mm



A6V-212 (52-07)
362W x 265D x 571H mm



MOQ 030
A6-224P (52-08)
362W x 265D x 571H mm



A6V-330 (52-09)
533W x 265D x 937H mm
A6V-330D (52-10) 加門型
533W x 313D x 970H mm

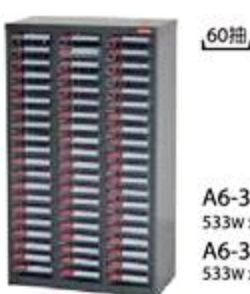

A6-360P (52-11)
533W x 265D x 937H mm
A6-360PD (52-12) 加門型
533W x 313D x 970H mm

OA
樹德櫃

SC
置物櫃

WB
工作桌

ST
零件櫃

FO
快取盒

CT
工具車

HB
整理盒

TB
工具箱

SH
輕辦公

DD
文具整理

MB
居家收納

MTO
接單生產

A7V 耐重抽系列

| 抽屜型號 | 尺寸(mm) | 尺寸(inch) | 材質 | 容量 | 安全荷重 |
|------------|---------------|-------------------|--------|------|------|
| A7V drawer | 120Wx218Dx69H | 4.7"Wx8.5"Dx2.7"H | ABS/PS | 1.6L | 10Kg |

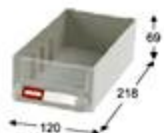

x1

- 全新ABS加長型耐油耐衝擊抽屜，搭配PS專利透明前視窗
- 極致安全防掉落抽屜，強力煞車不落地
- 耐重櫃體平均荷重**300kg**



16抽

A7V-416 (53-01)
586W x 222D x 350H mm



24抽

A7V-324 (53-02)
444W x 222D x 642H mm



48抽

A7V-448 (53-03)
586W x 222D x 937H mm
A7V-448D (53-04) 加門型
586W x 270D x 970H mm

A8 經典抽系列

| 抽屜型號 | 尺寸(mm) | 尺寸(inch) | 材質 | 容量 | 安全荷重 |
|------------|--------------|-------------------|-----|------|------|
| A8N drawer | 90Wx218Dx70H | 3.5"Wx8.5"Dx2.7"H | ABS | 1.2L | 10Kg |
| A8 drawer | 90Wx218Dx70H | 3.5"Wx8.5"Dx2.7"H | PS | 1.2L | 5Kg |

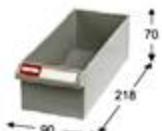

x1

- ABS耐油耐衝擊抽屜 PS高透明抽屜方便管理
- 耐重櫃體平均荷重**300kg**



16抽

A8-416 (53-05)
466W x 222D x 350H mm



20抽

A8-520 (53-06)
586W x 222D x 350H mm



15抽

A8-315 (53-07)
355W x 222D x 415H mm



32抽

A8-432 (53-08)
466W x 222D x 642H mm



60抽

A8-560 (53-09)
586W x 222D x 937H mm
A8-560D (53-10) 加門型
586W x 270D x 970H mm

活動底座

建議安全荷重 loading capacity **300kg**



W-6045 (53-11)
596W x 454D x 160H mm



適用型號:

A7-448 x2
A8-560 x2
ST1-575 x2
ST2-460 x2

ST1 經典抽系列

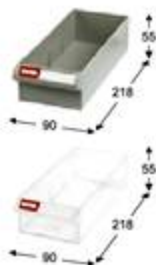

x1

- **ABS**耐油耐衝擊抽屜 **PS**高透明抽屜方便管理
- 耐重櫃體平均荷重**300kg**



25抽
ST1-525 (54-01)
586W x 222D x 350H mm



20抽
ST1-420 (54-02)
466W x 222D x 350H mm



18抽
ST1-318 (54-03)
355W x 222D x 415H mm



40抽
ST1-440 (54-04)
466W x 222D x 642H mm



75抽
ST1-575 (54-05)
586W x 222D x 937H mm
ST1-575D (54-06) 加門型
586W x 270D x 970H mm

ST2 經典抽系列

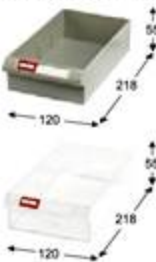

x1

- **ABS**耐油耐衝擊抽屜 **PS**高透明抽屜方便管理
- 耐重櫃體平均荷重**300kg**

| 抽屜型號 | 尺寸(mm) | 尺寸(inch) | 材質 | 容量 | 安全荷重 |
|-------------|---------------|-------------------|-----|------|------|
| ST2N drawer | 120wx218Dx55H | 4.7"wx8.5"Dx2.1"H | ABS | 1.2L | 10Kg |
| ST2 drawer | 120wx218Dx55H | 4.7"wx8.5"Dx2.1"H | PS | 1.2L | 5Kg |



20抽
ST2-420 (54-07)
586W x 222D x 350H mm



30抽
ST2-330 (54-08)
444W x 222D x 642H mm



60抽
ST2-460 (54-09)
586W x 222D x 937H mm
ST2-460D (54-10) 加門型
586W x 270D x 970H mm

OA
樹德櫃

SC
置物櫃

WB
工作桌

ST
零件櫃

FO
快取盒

CT
工具車

HB
整理盒

TB
工具箱

SH
輕辦公

DD
文具整理

MB
居家收納

MTO
接單生產

MC 多用途手機櫃系列 Mobile Cabinets

保護管理每一個獨特的隱私 加密保障每一個成功的智慧

保護工作夥伴重要的3C產品，讓全員一同全心投入產線工作中



- MC-525 置物空間，寬14.2cm 深21.9cm 適用大尺寸手機
- MC-210 置物空間，寬37.8cm 深21.9cm 適用平板及一般小筆電
- 固定式置物層板，隱私更有保障
- 每隔均附EVA保護墊(白)

鋼製櫃體

本公司不惜提升製作成本，推出極限品質產品
全部櫃體以進口Alloy鍍鋅鋼板製作，與市面一般
合金鍍或金屬鍍資料櫃不同，不易生鏽、堅固耐用。

材質: 0.8mm 日本進口Alloy特殊的鍍鋅鋼板
規格: 0.7mm 鍍鋅鋼板
烤漆: 0.1mm 高溫粉體塗裝，耐磨抗刮，長時間使用不易生鏽



MC 多用途手機櫃系列 Mobile Cabinets

門片規格

MC-5 系列

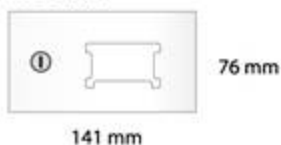

MC-210



置物空間尺寸

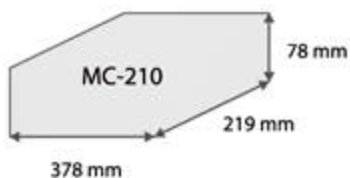
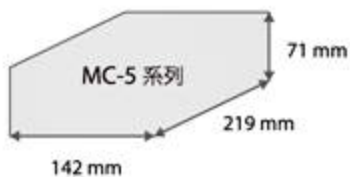

MC-210 (56-01) 10格
766W x 240D x 447H mm



MC-515 (56-02) 15格
766W x 240D x 291H mm



MC-525 (56-03) 25格
766W x 240D x 447H mm



MC-535 (56-04) 35格
766W x 240D x 603H mm



MC-545 (56-05) 45格
766W x 240D x 759H mm

OA
樹德櫃

SC
置物櫃

WB
工作桌

MC
手機櫃

FO
快取盒

CT
工具車

HB
整理盒

TB
工具箱

SH
輕辦公

DD
文具整理

MB
居家收納

MTO
接單生產



FO 快取分類盒系列
Quick Tip Out Bins

鳩尾槽設計，模組化的層疊延伸
創造無限收納的空間

FO 快取分類盒系列

掀開式抽屜快取功能，輕拉即出，輕推旋入，輕鬆拿取不費力

容量 capacity 安全荷重 loading capacity



8格 FO-308 (58-01) 0.2 L 0.4 KG
303W x 87D x 203H mm



6格 FO-306 (58-02) 0.5 L 1 KG
303W x 106D x 253H mm



5格 FO-605 (58-03) 0.8 L 2.5 KG
603W x 123D x 153H mm



4格 FO-604 (58-04) 1.85 L 4.5 KG
603W x 167D x 203H mm

內徑尺寸 Inner Dimensions

| 型號 | W | D | H | 容量 | 安全荷重 |
|--------|-------|-------|-------|--------|--------|
| FO-308 | 58.4 | 54.9 | 63.5 | 0.2 L | 0.4 kg |
| FO-306 | 80.8 | 72.2 | 79.8 | 0.5 L | 1 kg |
| FO-605 | 103 | 87.3 | 99.3 | 0.8 L | 2.5 kg |
| FO-604 | 128.9 | 122.6 | 132.1 | 1.85 L | 4.5 kg |

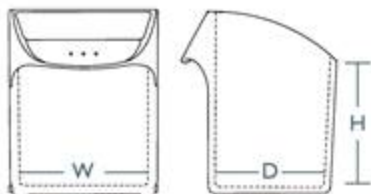

特色說明 Description

1. 背部開孔設計，內附完整背掛螺絲組
2. 端尾槽設計專利，可上下左右連結



SGS

專利 SGS測試

通過SGS測試，符合歐盟食品級檢驗
多國專利，中國、美國、歐盟...等32國專利
Patent NO. M349710, M360118



OA 樹德櫃
SC 置物櫃

WB 工作桌

ST 零件櫃

FO 快取盒

CT 工具車

HB 整理盒

TB 工具箱

SH 輕辦公

DD 文具整理

MB 居家收納

MTO 接單生產

MS-FO 掀開式快取零物件分類車

Quick Flip Out Bins with Mobile Stands

全球唯一 極致創新
業界首創 物料定點管理供給裝備

樹德睿智研發，整座式移動，隨時待命支援補給，您的生產裝配線。

RFO 快取盒旋轉架 Revolving Tower Hanging Bins

- 瘦長柱體，最省空間，創造出最大物料配置效率
- 旋轉式底座，加速搜尋物料速度
- 36, 48, 90, 144 四種格數，多樣選擇彈性選配



RFO-848 (60-01)
449W x 518.3D x 430H mm
FO-308 x6 sets



RFO-636 (60-02)
449W x 518.3D x 530H mm
FO-306 x6 sets



RFO-8144 (60-03)
449W x 518.3D x 1230H mm
FO-308 x18 sets



RFO-690 (60-04)
449W x 518.3D x 1280H mm
FO-306 x15 sets

MS-FO 快取分類車 DIY商品，若需組裝酌收500元/台 Quick Tip Out Bins with Mobile Stands

尺寸會較高，倉把手寬750mm

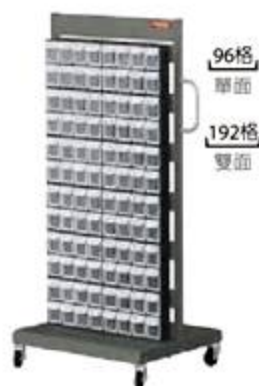

MS-18000 單面
FO-308 x12 sets (60-05)

MS-28000 雙面
FO-308 x24 sets (60-06)
690W x 560D x 1460H mm



MS-16000 單面
FO-306 x10 sets (60-07)

MS-26000 雙面
FO-306 x20 sets (60-08)
690W x 560D x 1460H mm



MS-15000 單面
FO-605 x8 sets (60-09)

MS-25000 雙面
FO-605 x16 sets (60-10)
690W x 560D x 1460H mm



MS-14000 單面
FO-604 x6 sets (60-11)

MS-24000 雙面
FO-604 x12 sets (60-12)
690W x 560D x 1460H mm

樹德的移動城堡 快取車依需求，可自由搭配快取盒FO或背掛板HP 背掛式整理盒HB，工業掛勾組HK使用

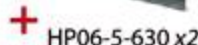
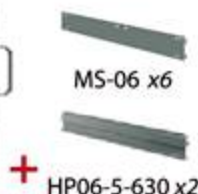
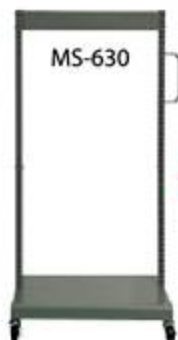

HP06-8-630 x2
656W x 32D x 400H mm



FO-308 x2



FO-306 x2



FO-605 x2



FO-604 x2



MS-2M202 (60-13)
690W x 560D x 1460H mm

OA 樹德櫃

SC 置物櫃

WB 工作桌

ST 零件櫃

FO 快取盒

CT 工具車

HB 整理盒

TB 工具箱

SH 輕辦公

DD 文具整理

MB 居家收納

MTO 接單生產

CT 專業重型工具車系列
Ultra Heavy-duty Cart Series

移動中提升生產效率與品質

效率空間的創造者，專業的工作態度從這裡開始



■ 特色說明 Features

DIY商品，若需組裝酌收500元/台

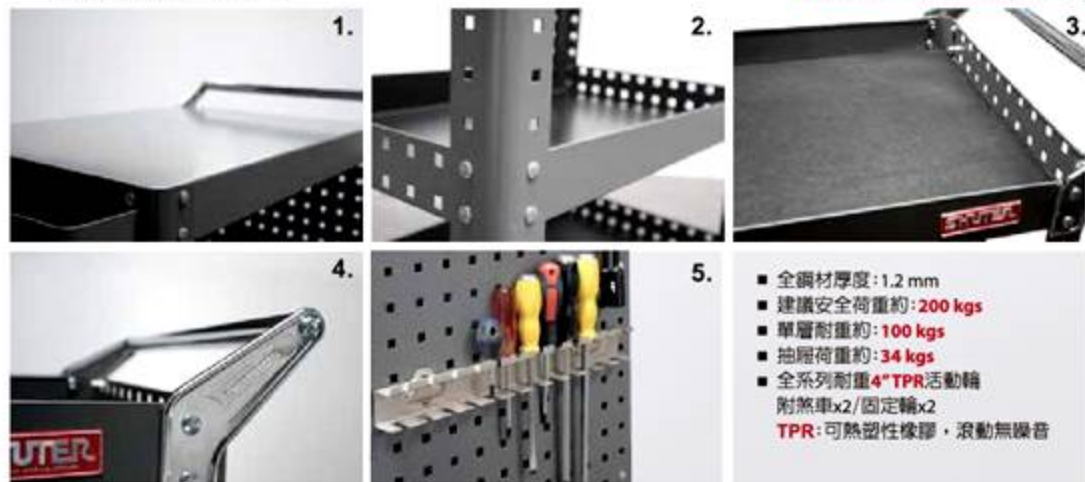

1. 兩用式多用層板，翻面組裝可當桌面使用
2. 層板採方形孔設計，可依需求靈活調整層板高度
3. 每層層板均耐油性 EVA 止滑墊
4. 鋼製把手結構強化設計，堅固耐用
5. 側掛板採用國際方形沖孔規格，可依需求選購掛鉤使用



DIY



高荷重



粉剝烤漆



SGS測試

■ 背掛組合 (選購)

CW62/63需搭配
快取盒組合



CW60 (62-01)
674W x 250D x 632H mm



CW61 (62-02)
674W x 250D x 632H mm



CW62 (62-03)
674W x 250D x 632H mm
FO-604x2



CW63 (62-04)
674W x 250D x 632H mm
FO-605x3, FO-306x4
FO-308x4



CT-1 (62-05)
873W x 500D x 880H mm
TPR 4" caster (原CTC-5086)



CT-2 (62-06)
873W x 500D x 1070H mm
TPR 4" caster



CT-C3A (62-07)
873W x 500D x 880H mm
TPR 4" caster (原CTC-5086)



CT-C3B (62-08)
873W x 500D x 880H mm
TPR 4" caster (原CTC-5086)



CT-H (62-09)
873W x 500D x 880H mm
TPR 4" caster (原CTH-5086)



CT-H3 (62-10)
873W x 500D x 880H mm
TPR 4" caster (原CTH-5086)



CT-HD (62-11)
873W x 500D x 880H mm
TPR 4" caster (原CTH-5086D)



CT-H7 (62-12)
873W x 500D x 880H mm
TPR 4" caster (原CTH-5086)

MOQ 030

MOQ 030

MOQ 030

OA
樹德櫃

SC
置物櫃

WB
工作桌

ST
零件櫃

FO
快取盒

CT
工具車

HB
整理盒

TB
工具箱

SH
輕辦公

DD
文具整理

MB
居家收納

MTO
培壁生產

TC 專業活動工具車系列 Professional Ultra Heavy-duty Cart Series



■ 背掛組合 (選配)



W60 (63-01)
656W x 32D x 700H mm



W61 (63-02)
656W x 32D x 700H mm



■ 搭配快取盒背掛組合 W+MS-06x3+FO-605x3

把東西放在對的地方
專業的工作態度從這裡開始

背掛式工具整理車，使用上更加得心應手，效率倍增。

■ 特色說明 Features



高荷重 耐刮烤漆 SGS測試

- 全鋼材厚度: 1.2 mm
- 建議安全荷重約: 400 kgs
- 抽屜荷重約: **30 kgs**
- 全系列耐重PP活動輪
- 附煞車x2/固定輪x2

DV-243S
格片組 一組內附(可加購)

-  x 2
-  x 4
-  x 3



NEW Square box

抽屜內附方塊盒組
詳細說明請翻閱 P. 79

1. 轉角靠弧設計, 降低工作時碰撞的傷害
2. 方形孔掛板組, 方便拿取常用工具, 工作更順暢
3. 抽屜加鎖, 安心擺放重要工具
4. 抽屜安全鎖扣, 避免抽屜滑出、翻落的危險
5. 圓形把手, 弧型設計, 更符合人體工學

 安全荷重
loading capacity



TC-25 (64-01) 
680W x 460D x 1015H mm
PP 5" caster (原NTC-LT25)



TC-H25 (64-02) 
680W x 460D x 1015H mm
PP 5" caster (原NTC-LHP25)



NEW TC2-L25 (64-03) 
671W x 460D x 975H mm
PP 5" caster



NEW TC-S22 (64-04) 
671W x 347D x 650H mm
PP 3" caster



TC-S23 (64-05) 
570W x 342D x 779H mm
Rubber 4" caster



NEW TC2-M23 (64-06) 
671W x 460D x 820H mm
PP 5" caster

OA
樹德櫃

SC
置物櫃

WB
工作桌

ST
零件櫃

FO
快取盒

TC
工具車

HB
整理盒

TB
工具箱

SH
輕辦公

DD
文具整理

MB
居家收納

MTO
培華生產

TW 刀具存放系列 CNC Tool Storage Cabinets & Racks Series

專業刀具車/刀具架/刀具庫

萬用規格符合各國刀具尺寸

全鋼材厚度1~1.6mm

K/D設計，便於海運

粉體烤漆車體，耐磨損及溶劑侵蝕

全系列輪組為TPR超耐重4"車輪



DIY



高荷重



耐刮漆漆



SGS測試



把刀桿放在對的地方
台灣刀具分類整理的原創廠商

為您專業貴重的刀具找到最妥當的放置場域
刀具車移動自如，各式刀座尺寸齊全。

PUT TOOLINGS AT RIGHT PLACE

固定式刀具架系列 CNC Tool Storage Cabinets & Racks

KG 安全荷重 loading capacity

DIY商品 · 若需組裝酌收500元/台



500 KG

TW-1F (66-01)
892W x 634D x 1704H mm
可放BT-40刀具座56/pc



500 KG

TW-2F (66-02)
892W x 634D x 1704H mm
可放BT-40刀具座112/pc



200 KG

接單生產
RT-6558 (66-03)
653W x 600D x 1460H mm
可放BT-40刀具座每層7/pc

加門型刀具庫



THD-3B (66-04)
880W x 400D x 880H mm
可放BT-40刀具座每層10/pc

刀具車系列 Professional CNC Tool carts 建議安全荷重 loading capacity **200kg**

DIY商品 · 若需組裝酌收500元/台 (可變更刀具座)



TW-4B2D (66-05)
1002W x 650D x 810H mm
可放BT-40刀具座28/pc



TW-4B1D (66-06)
1002W x 650D x 810H mm
可放BT-40刀具座28/pc



TW-4B (66-07)
1002W x 650D x 810H mm
可放BT-40刀具座28/pc



TWE-3B (66-08)
939W x 458D x 897H mm
可放BT-40刀具座21/pc

■ 背掛組合 (選配)



W60 (66-09)
656W x 32D x 700H mm







W61 (66-10)
656W x 32D x 700H mm

■ 刀具移動座 (選配)



BTS-595 (66-11)
595W x 143D x 225H mm

■ 刀具座規格 (選配)

| 刀具座 | * 歐洲規格 | | | |
|-----------|---|---|---|--|
| 材質: ABS樹脂 |  |  |  |  |
| 型號 | BT-30 (66-12) 64W x 137D x 48H mm | BT-40 (66-13) 74W x 137D x 63H mm | BT-50 (66-14) 104W x 137D x 93H mm | HSK-63 (66-15) 84W x 137D x 49H mm |
| 單排刀具架 | 8 pcs | 7 pcs | 5 pcs | 6 pcs |
| of TW-1F | 64 pcs | 56 pcs | 40 pcs | 48 pcs |
| of TW-2F | 128 pcs | 112 pcs | 80 pcs | 96 pcs |

OA 樹德櫃

SC 置物櫃

WB 工作桌

ST 零件櫃

FO 快取盒

TW 刀具車

HB 整理盒

TB 工具箱

SH 輕辦公

DD 文具整理

MB 居家收納

MTO 接單生產

HB 耐衝擊分類置物盒系列 Ultra Stack & Hanging Bins Series

高效率工作空間的標準配備

輕巧DIY出您的工作環境，可承載重量超乎您的想像。



■ 特色說明 Features



高荷重



SGS測試

- 可利用加高柱上下左右結合使用
- 取物置料口加高設計更方便、更好拿
- 左右連結，增加組合穩定度
- 內徑長寬加大設計，容量更大
- 標示卡可抽換，方便儲存管理
- 全系列人體工學，快取滑道設計

OA 樹德櫃

SC 置物櫃

WB 工作桌

ST 零件櫃

FO 快取盒

TW 刀具車

HB 整理盒

TB 工具箱

SH 輕辦公

DD 文具整理

MB 居家收納

MTO 接單生產



■ 附隔板 Clapboard



HB-235
HB-250

| | | |
|---|---|---|
| 1 | 2 | 3 |
| 4 | 5 | 6 |

1. 可使用腳柱層疊
2. 可左右連結，增加組合穩定度
3. 產品側邊手握設計，方便拿取
4. 可背掛設計
5. HB-250 內附輪組
6. HB-250 & HB-235 附隔板

■ 腳柱樣式高度說明 Supporting Column Increased Height



HB-239
HB-240
HB-250



H=128.5 mm

HB-230
HB-235



H=118 mm

HB-210
HB-220



H=77 mm

■ HB 系列  容量 capacity  安全荷重 loading capacity

內容物



標示卡



壓板

產品顏色



MOQ 按單生產色

| | | | |
|--------|--------|---------|--------|
| HB-210 | 3000 個 | HB-1218 | 4000 個 |
| HB-220 | 3000 個 | HB-1525 | 2000 個 |
| HB-230 | 1800 個 | HB-2035 | 2000 個 |
| HB-235 | 1400 個 | HB-2045 | 1200 個 |
| HB-239 | 1500 個 | HB-3045 | 1200 個 |
| HB-240 | 1400 個 | HB-4068 | 600 個 |
| HB-250 | 1200 個 | | |

隔板



HB-235
HB-250
HB-4135



HB-210 (69-01)
105W x 137D x 76H mm

 0.6 L  15 KG 60pcs / 箱



HB-220 (69-02)
105W x 187D x 76H mm

 0.8 L  15 KG 60pcs / 箱



HB-230 (69-03)
145W x 276D x 127H mm

 2.7 L  20 KG 30pcs / 箱



HB-235 (69-04)
279W x 276D x 127H mm

 6.4 L  30 KG 24pcs / 箱



HB-239 (69-05)
210W x 273D x 178H mm

 6.6 L  30 KG 20pcs / 箱



HB-240 (69-06)
210W x 375D x 178H mm

 9.6 L  30 KG 20pcs / 箱



HB-250 (69-07)
420W x 375D x 178H mm

 21 L  50 KG 10pcs / 箱

HB 整理盒

■ HB 經典系列



HB-1218 (69-08)
121W x 180D x 84H mm

 1 L  3 KG 60pcs / 箱



HB-1525 (69-09)
150W x 265D x 121H mm

 2.5 L  6 KG 36pcs / 箱



HB-2035 (69-10)
208W x 353D x 155H mm

 6 L  20 KG 18pcs / 箱



HB-2045 (69-11)
205W x 480D x 178H mm

 10 L  30 KG 12pcs / 箱

TB 工具箱

SH 輕辦公

DD 文具整理

MB 居家收納

MTO 按單生產



HB-4135 (69-12)
415W x 351D x 154H mm

 13 L  15 KG 12pcs / 箱



HB-3045 (69-13)
300W x 480D x 178H mm

 16 L  50 KG 12pcs / 箱



HB-4068 (69-14)
395W x 635D x 335H mm

 50 L  30 KG 4pcs / 箱

■ HB 經典系列特色說明 Features

荷重腳柱

全新改良希臘圓柱式
加高柱結構補強設計
承重力更大

防塵蓋

全新結構
拉力彈簧設計
自動緊閉功能

標示卡

標示前傾設計
方便站立時辨識

平行結合

可左右連結，增加組合穩定度

- 背對背連結扣，固定穩固，方便雙向儲存作業
- 內徑長寬加大設計，容量更大
- 全系列人體工學，快取滑道設計，更方便、更好拿

強化結構

側體結構，溝槽補強設計

52mm

輪組 (選購)
使用機動更加便利



加高柱可增加52mm高，拿取更方便



左右軌道可連續平行結合



皆附1或1.75mm厚透明壓板與標示卡紙

■ 選購配件 Accessory

背對背連結扣 Caster's connecting clip



HB-2035
HB-2045
HB-3045



HB-2035 管塞

腳柱 Unique supporting column



層疊增加
34mm



層疊增加
52mm

防塵蓋 Dust cover

厚度: 1.5mm 貼心好用 組裝容易



18pcs/包

C-2035 (70-01)
205W x 371D x 9H mm



18pcs/包

C-1525 (70-02)
149W x 283D x 9H mm



拉力彈簧設計

HB-1218
HB-1525

HB-2035
HB-2045
HB-3045
HB-4135

OA 樹德櫃

SC 置物櫃

WB 工作桌

ST 零件櫃

FO 快取盒

TW 刀具車

HB 整理盒

TB 工具箱

SH 輕辦公

DD 文具整理

MB 居家收納

MTO 接單生產

MS-HB 工業效率車

Mobile Stand Hanging Bins

KG 安全荷重
loading capacity

DIY商品 · 若需組裝約收500元/台

OA 樹德櫃

SC 置物櫃

WB 工作桌

ST 零件櫃

FO 快取盒

TW 刀具車

HB 效率車

TB 工具箱

SH 輕辦公

DD 文具整理

MB 居家收納

MTO 接單生產



MS-HC (71-01)
932W x 619D x 958H mm
TPR 3"caster
HP-08-5 x6 **200 KG**
851W x 22.2D x 97H mm

商品不含掛板 HP-08-5



MS-HT (71-02)
885W x 600D x 919H mm
TPR 3"caster
HP-08-5 x6 **200 KG**
8851W x 22.2D x 97H mm

商品不含掛板 HP-08-5



MS-HB (71-03) **250 KG**
893W x 600D x 1593H mm
TPR 3"caster
HP-08-5 x7

商品不含掛板 HP-08-5



MS-HB+H-M001 (71-04) **250 KG**
893W x 600D x 1593H mm
TPR 3"caster
HB-210x8, HB-220x8, HB-230x6
HB-235x3, HB-239x4, HB-240x4
HB-250x2



強化結構更耐重



掛板安全荷重 HP-08-5



輪組安全荷重 3"TPR caster
TPR: 可熱塑性橡膠



H1081
HB-210x8



H2081
HB-220x8

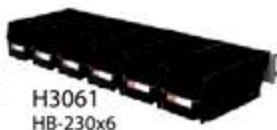

H3061
HB-230x6



H3531
HB-235x3



H3941
HB-239x4



H4041
HB-240x4



H5021
HB-250x2

RC 工業效率架 Heavy Duty Shelves

DIY商品，若需組裝酌收500元/台



DIY



高承重



耐刮烤漆



SGS測試



RC-9520 (72-01)
943W x 465.4D x 2030H mm

700 KG 安全荷重
loading capacity

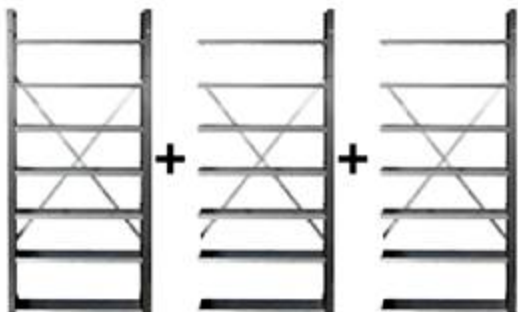

- 效率架可左右擴充組合，層板材質為熱浸鍍鋅鋼板
- 層板耐重100kg，整體安全荷重700kg
- 可搭配HB系列整理盒或HD-1641抽屜

特色說明 Features



| | | |
|---|---|---|
| 1 | 2 | 3 |
| 4 | | |

- 層板鉤免螺絲
- 專利層板鉤，層板更牢固
- 層板高低可調，每層建議荷重100kg
- 效率架可左右擴充組合

OA
樹德櫃

SC
置物櫃

WB
工作桌

ST
零件櫃

FO
快取盒

TW
刀車

RC
效率架

TB
工具箱

SH
輕辦公

DD
文具整理

MB
居家收納

MTO
接單生產

TB 專業用工具箱系列 Professional Tool Boxes



讓台灣成為世界第一工具箱製造國

我們重視產品細節與品質，採用高耐衝擊全新原料，讓它陪在你身邊的時間多更多，全以金屬零件連接把手及前後扣環，並以手工精心組裝，多到加工程序超越品質極限。

樹德 自1979年來生產的TB-611工具箱共累積230萬個，全部堆疊起來比623座101大樓還高。

TB-611 (73-01)
440W x 197.2D x 140H mm
17.3"W x 7.7"D x 5.5"H inch

■ 工具箱圖示說明 Toolbox Illustrates



■ 功能介紹 Features description

SO-1314



TB-905t 上蓋附小集盒2入



TB-905t/ TB-902t 內盒型式



TB-905t/ TB-902t 內盒提把設計方便作業需求



TB-802 雙層抽屜簡易鎖扣



TB-802 / TB-800 上蓋可掀開靈活儲物空間，附隔片



TB-802 底部強化鋼條，耐重不變形



TB-611 內盒型式



TB-800 內盒型式，附隔片



TB-901 內盒型式



TB-104 內盒型式



TB-102 內盒型式



TB-402 內盒型式

OA 樹德櫃

SC 置物櫃

WB 工作桌

ST 零件櫃

FO 快取盒

CT 工具車

HB 整理盒

TB 工具箱

SH 輕辦公

DD 文具整理

MB 居家收納

MTO 接單生產

TB 專業用工具箱系列 Professional tool boxes

OA 樹德櫃

SC 置物櫃

WB 工作桌

ST 零件櫃

FO 快取盒

CT 工具車

HB 整理盒

TB 工具箱

SH 輕辦公

DD 文具整理

MB 居家收納

MTO 接單生產



NEW

TB-611 (75-01)
440W x 197.2D x 140H mm
17.3"W x 7.7"D x 5.5"H inch



10入/箱



NEW

TB-402 (75-02)
440W x 197.2D x 170H mm
17.3"W x 7.7"D x 6.7"H inch



10入/箱



TB-102 (75-03)
426W x 235D x 180H mm
16.8"W x 9.3"D x 7.1"H inch



6入/箱



TB-104 (75-04)
426W x 235D x 225H mm
16.8"W x 9.3"D x 8.9"H inch



6入/箱



TB-800 (75-05)
558W x 277D x 270H mm
22"W x 11"D x 10.6"H inch



4入/箱



TB-802 (75-06)
558W x 277D x 370H mm
22"W x 11"D x 14.6"H inch



4入/箱



TB-901 (75-07)
380W x 178D x 143H mm
15"W x 7"D x 5.6"H inch
10入/箱



TB-902t (75-08)
445W x 240D x 205H mm
17"W x 9.3"D x 8.1"H inch
6入/箱



TB-905t (75-09)
445W x 240D x 205H mm
17.4"W x 9.4"D x 8.1"H inch
6入/箱





MCA 曲木文件車系列 Polywood File Cart

輕鬆妝點優雅的生活辦公 移動生活美學的獨特品味

在忙碌的工作環境中，有著不急不徐的態度，優雅地將文件安全送到同事手中，今天也一樣美好！

- 櫃體：10mm一體成型曲木板
- 底座：鍍鋅鋼板防鏽粉體烤漆
- 輪子：60mm防壓痕輪（適用木地板），耐重達100公斤



SOHO 輕辦公文件車系列

Exceptional Motion Cart



DDH-106HM (78-01)
367W x 265D x 635H mm



DDH-106HF (78-02)
367W x 265D x 675H mm



DDH-106H1S (78-03)
367W x 450D x 635H mm



A4X-101HEM (78-04)
304W x 500D x 652H mm

OA 樹德櫃

SC 置物櫃

WB 工作桌

ST 零件櫃

FO 快取盒

CT 工具車

HB 整理盒

TB 工具箱

SH 輕辦公

DD 文具整理

MB 居家收納

MTO 接單生產



EMC 鍍金文件車系列

- 櫃體: 鍍鉍鋼板防鏽粉體烤漆
- 底座: 鍍鉍鋼板防鏽粉體烤漆
- 輪子: 60mm 防壓痕輪 (適用木地板) 耐重達100公斤
- 輪蓋子可打開 又是一個儲存空間



A4X-106HM (78-05)
315W x 400D x 627H mm



A4X-105HM (78-06)
315W x 400D x 627H mm



A4X-101HM (78-07)
315W x 400D x 627H mm



■ 輕鬆滑動托盤

■ 適用於文件持有人

■ 橫式抽屜(A4)

■ 適於儲存文具及小物



A



B



C



D

- A. 曲木文件車
MCA-DH6H (78-08)
357W x 328D x 732H mm
- B. 曲木文件車
MCA-DH3P (78-09)
357W x 328D x 732H mm
- C. 鍍金文件車
NCA-DH6H (78-10)
333W x 328D x 730H mm
- D. 鍍金文件車
NCA-DH3P (78-11)
333W x 328D x 730H mm

OA
樹德櫃SC
置物櫃WB
工作桌ST
零件櫃FO
快取盒CT
工具車HB
整理盒TB
工具箱SH
輕辦公DD
文具整理MB
居家收納MTO
接單生產

SOHO 家庭工作站

Reading & Working

只屬於自己的工作空間

把工作區域完美的融入居家生活，創造出一種輕鬆自在又有效率的居家工作新風格。



和風書桌 Working Table



梯形書架



- 內附固定牆面配件(壁虎)
- 支架砂膠墊保護牆面及地板
- 牆面提供了最堅固穩定的支撐

SHS-1628 (79-02)
759W x 428D x 1650H mm



■ 桌面特殊溝槽設計收納電線



■ 電線/延長線...等收納空間



■ 階梯式層板 方便放置物品

SOHO 書架系列 Bookshelf Series

簡約設計的極致，人文氣息的迂迴眷戀。



TR-3470 天然竹片的材質

KD包裝，可以DIY自行組裝，省下材積也省下運送成本。
即使在小地方，我們也一直為您著想。



MOQ 030

TR-3470 (80-01)
340W x 318D x 695H mm

MOQ 030

SW-4080 (80-02)
400W x 300D x 800H mm

MOQ 030

RW-60 (80-03)
600W x 350D x 1480H mm

MOQ 030

SH-05 (80-05)
800W x 300D x 1260H mm

SH-60 (四層) (80-06)
660W x 318D x 1800H mm

MOQ 030

RW-35 (80-04)
350W x 350D x 1480H mm

SH-75 (四層) (80-07)
750W x 318D x 1800H mm

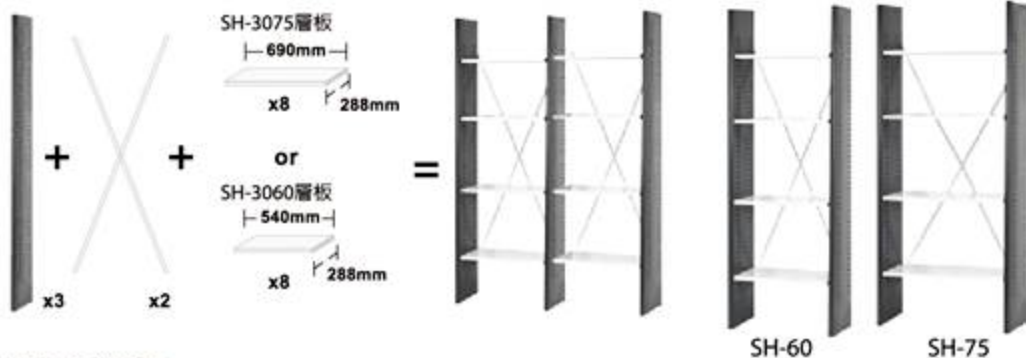

北歐文件櫃 Steel Document Cabinet

材質：1.0mm鋼板



MOQ 030

MF-106 (80-08)
282W x 402D x 720H mm

MOQ 030

MT-108s (80-09)
282W x 380D x 590H mm

OA 樹德櫃

SC 儲物櫃

WB 工作桌

ST 零件櫃

FO 快取盒

CT 工具車

HB 整理盒

TB 工具箱

SH 輕辦公

DD 文具整理

MB 居家收納

MTO 接單生產

OA 樹德櫃

SC 置物櫃

WB 工作桌

ST 零件櫃

FO 快取盒

CT 工具箱

HB 整理盒

TB 工具箱

SH 輕辦公

DD 文具整理

MB 居家收納

MTO 接單生產



SB 方塊盒系列

Square Box

剛好的組合是最美的相遇

剛剛好是可遇不可求的事，在有限的空間裡分割出更多樣的區塊，能一眼看見物件的所在處，多種尺寸多種顏色搭配出最繽紛的姿態。

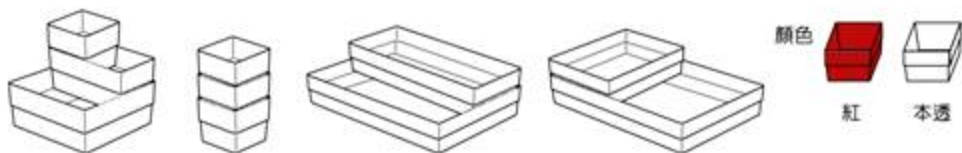

SB-0707H (81-01)
70W x 70D x 62H mm



SB-0714H (81-02)
70W x 140D x 62H mm



SB-1414H (81-03)
140W x 140D x 62H mm



SB-1813L (81-04)
180W x 130D x 45H mm



SB-1826L (81-05)
180W x 260D x 45H mm



SB-0926L (81-06)
90W x 260D x 62H mm

Square
box



CW61

MC 北歐金屬置物箱

OA 樹德櫃

SC 置物櫃

WB 工作桌

ST 零件櫃

FO 快取盒

CT 工具車

HB 整理盒

TB 工具箱

SH 輕辦公

DD 文具整理

MB 居家收納

MTO 接單生產



MC-2433 (80-01)
238W x 335D x 260H mm

MOQ 030

MC-1715 (80-02)
170W x 335D x 155H mm

MOQ 030

MC-1617 (80-03)
159W x 172D x 156H mm

MOQ 030

壁掛鑰匙箱
KB-1444 (80-04)
140W x 60D x 440H mm



MOQ 030

SB 方塊盒-內盒系列



SB-200 (80-05)
151W x 122D x 35H mm



SB-300 (80-06)
234W x 122D x 35H mm



SB-302 (80-07)
309W x 122D x 35H mm



SB-312 (80-08)
337W x 137D x 35H mm



OA 樹德櫃

SC 置物櫃

WB 工作桌

ST 零件櫃

FO 快取盒

CT 工具車

HB 整理盒

TB 工具箱

SH 輕辦公

DD 文具整理

MB 居家收納

MTO 接單生產

DD 桌上資料櫃系列 Desktop Drawers

讓文件分層式管理 創造桌面大空間

不同深度的抽屜，不只能放置A4文件，更達到多功能收納的目的，創造出更有效率的收納方式。



DDH 橫式資料櫃系列

Patent NO. M367648



DDH-103N (84-01)
340W x 250D x 150H mm 6入/箱



DDH-111N (84-02)
340W x 250D x 150H mm 6入/箱

DD 經典資料櫃系列



DD-105P (84-03)
250W x 340D x 230H mm 6入/箱

DD-113 (84-04)
250W x 340D x 230H mm 6入/箱

DD-106P (84-05)
250W x 340D x 270H mm 6入/箱



DD-121 (84-06)
250W x 340D x 230H mm 6入/箱

DD-105S (84-07)
250W x 340D x 230H mm 6入/箱

DD-114 (84-08)
250W x 340D x 270H mm 6入/箱

MOQ 1000個

OA
樹德櫃

SC
置物櫃

WB
工作桌

ST
零件櫃

FO
快取盒

CT
工具箱

HB
整理盒

TB
工具箱

SH
輕辦公

DD
文具整理

MB
居家收納

MTO
接單生產

OA 樹德櫃

SC 置物櫃

WB 工作桌

ST 零件櫃

FO 快取盒

CT 工具車

HB 整理盒

TB 工具箱

SH 輕辦公

OA 文具整理

MB 居家收納

MTO 接單生產

OA 公文分類盒系列

Letter Tray

分類決定效率

工作桌上的文件——分類後 頭腦也會變得更清晰

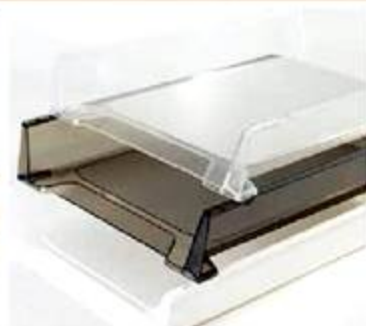

1. 三段式調整設計，斜面讓您更容易抽取和放置文件
2. 後方設有支撐點，堆再高也不易搖晃
3. 大空間設計，再多的工作量也能應付
4. 可堆疊收納，節省桌面空間



OA-2937 (85-01)
284W x 366D x 64H mm 單層高度
25入/箱



OA-2736 (85-02)
263W x 354D x 60H mm 單層高度
3層-10入/箱 5層-6入/箱



OA-2634 (85-03)
260W x 335D x 77H mm 單層高度
6入/箱

OF 隨身攜行隨意盒

File Organiser & Letter Tray

隨手保護重要文件

手上的文件可能很輕易的被丟失了，需要一個堅固、密封又方便攜帶的文件盒，保護每個文件以及文具的完整性。



扣環資料夾



MOQ 1500個

OF-A02 (86-01)
285W x 344D x 27H mm
40入/箱



OF-A03 (86-02)
318W x 240D x 25H mm
60入/箱



MOQ 1900個

OF-B01 (86-03)
280W x 375D x 30H mm
30入/箱



OF-C02 (86-04)
350W x 270D x 46H mm
24入/箱



MOQ 2000個

FH4-3128 (86-05)
318W x 285D x 38H mm
12入/箱

巧拼資料箱

Filing Cube Set

A4 吊掛分類資料箱

- 符合不同尺寸的文件 設計風格簡單又時尚
- 特殊設計緊密扣環保護隨意盒不會鬆開



KD6F-2638 (86-06)
380W x 380D x 260H mm

資料文件箱(含6個懸掛式資料夾)



CT-40 (86-07)
Ø 40 mm

可搭配輪組移動時更省力



KD6F1L-2638 (86-08)
380W x 380D x 260H mm

KDL-2038 (86-09)
388W x 388D x 20H mm

上蓋(適合KD6F-2638/KD-2638)



A4-12F (86-10)
345W x 253D x 25H mm

懸掛式資料夾補充包 黑6入+白6入/包



OA 樹德櫃
SC 置物櫃

WB 工作桌

ST 零件櫃

FO 快取盒

CT 工具車

HB 整理盒

TB 工具箱

SH 輕辦公

DD 文具整理

MB 居家收納

MTO 接單生產



MB 系統收納箱系列

MB drawer box

平凡的人 追不平凡的夢想
不平凡的人 尋平凡的生活

樂收FUN



■ 鋁條結構補強 抽屜拉抽順暢 不變形
(安全荷重5KG)



■ 可拆式面板 輕鬆拿取物件



■ 疊層穩固不滑動

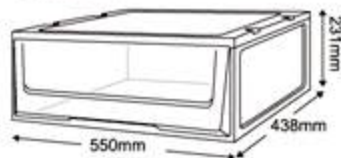

36 L
每抽容量36公升
5 KG
建議荷重5公斤

MB 連接板



MB-5501 (87-01)
550W x 438D x 233H mm



2入/組

MB55-200 (87-02)
247.4W x 410D x 22H mm



2入/組

MB55-300 (87-03)
347W x 410D x 22H mm



MB-5503 (87-04)
550W x 438D x 651H mm



MB-5505 (87-05)
550W x 438D x 1069H mm



OA 樹德櫃

SC 置物櫃

WB 工作桌

ST 零件櫃

FO 快取盒

CT 工具車

HB 整理盒

TB 工具箱

SH 輕辦公

DD 文具整理

MB 居家收納

MTO 接單生產

MB 系統收納箱系列

■ 搭配連接板 靈活運用收納空間



■ 鋁條結構補強，耐重壓
抽屜拉抽順暢



MB 連接板



MB-200 (88-01)
245W x 518D x 20H mm
2入/組



MB-300 (88-02)
348W x 518D x 20H mm
2入/組



MB-3501 (88-03)
350W x 550D x 200H mm



MB-3503 (88-04)
350W x 550D x 557H mm

OA 樹德櫃

SC 置物櫃

WB 工作桌

ST 零件櫃

FO 快取盒

CT 工具車

HB 整理盒

TB 工具箱

SH 輕辦公

DD 文具整理

KD 居家收納

MTO 接單生產

KD 巧拼收納箱系列

Knock Down Modular DIY System

INNO

CUBE1



巧妙拼出你的分隔世界

Patent NO. 3116269 M265354 ZL 2005 2 004425.X

方格子的排列組合，是創意的無限想像。
隨心情搭配喜愛的顏色，讓生活充滿趣味跟實在感。
您不需透過工具，用雙手即可輕鬆組裝。

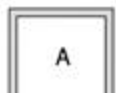

KD-2638X



KD-2625



KD-2619

KD系列組合示意圖：

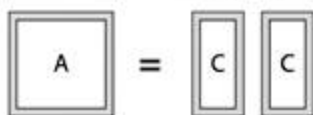



安全荷重(水平荷重)
loading capacity



OA 樹德櫃

SC 置物櫃

WB 工作桌

ST 零件櫃

FO 快取盒

CT 工具車

HB 整理盒

巧拼收納箱系列6入/箱



KD-2638X (90-01)
380W x 380D x 260H mm



KD-2625 (90-02)
380W x 250D x 260H mm



KD-2619 (90-03)
380W x 190D x 260H mm



KD-2638 (90-04)
380W x 380D x 260H mm



可搭配輪組移動時更省力



CT-30 (88-05)
Ø 40 mm

TB 工具箱

SH 輕辦公

DD 文具整理

KD 居家收納

MTO 接單生產

OA 樹德櫃

SC 置物櫃

WB 工作桌

ST 零件櫃

FO 快取盒

CT 工具車

HB 整理盒

TB 工具箱

SH 輕辦公

DD 文具整理

KD 居家收納

MTO 接單生產

KD 悠活置物箱系列 Knock Down Modular DIY System

INN□

CUBE2

追求生活質感的簡約設計

俐落的線條、貼心的防塵門片設計、空間配置更能随心所欲。





■ 附門片 防塵之餘更重隱私



■ 加層板 空間使用更多元



■ 可選購燈組



KD-2936A (92-02)
360W x 290D x 360H mm

- 新式垂直結構 不易變形搖晃
- 輕巧好組裝 無需使用工具
- 可依空間需求 收納多變化



置物箱燈組
KD-2936LT (92-01)
110V / 15W



KD-2936 (92-03)
360W x 290D x 360H mm



■ 空櫃 無私且大方分享



■ 包裝



OA 樹德櫃

SC 圓物櫃

WB 工作桌

ST 零件櫃

FO 快取盒

CT 工具車

HB 整理盒

TB 工具箱

SH 輕辦公

DD 文具整理

KD 居家收納

MTO 接單生產

OA 樹德櫃

SC 置物櫃

WB 工作桌

ST 零件櫃

FO 快取盒

CT 工具車

HB 整理盒

TB 工具箱

SH 輕辦公

DD 文具整理

MHB 居家收納

MTO 接單生產

MHB 大嘴鳥收納箱系列

Pelican Storage Bin

Patent NO. D147856 3175462 001296917-0001

安全荷重
建議容量  

- 尺寸多元可堆疊 提供更多更多變的收納組合
- 扁平接口的設計 提供內部更大的儲存空間
- 專利絞鏈結構 使蓋子維持打開狀態不咬你的手

讓家中的一角 加入一點繽紛的收放趣味

像一隻隻張著大嘴的鳥兒，期待著放飯時刻，大口吃著美味的餅乾零食、厚厚的書本與紙張、寶貝孩子的積木與小汽車！



MHB-2341 (93-01)
225W x 410D x 286H mm



MHB-3332 (93-02)
330W x 325D x 255H mm



MHB-3741 (93-03)
375W x 410D x 286H mm



MHB-4541 (93-04)
450W x 410D x 286H mm



MHB-3741L (93-05)
375W x 410D x 418H mm



RB 收納桶



RB-28 (93-06)
345W x 275D x 420H mm



RB-10 (93-07)
175W x 275D x 320H mm



DB 小房子整理箱系列 Patent NO. 002410811 3190370

Drop-down Door Storage

為珍藏回憶的寶盒，開啓一扇窗

拾起畫筆，為小屋開了窗、加了門，共同創作屬於我們的童趣生活。

- 雙開口設計 放入取出好方便
- 側面門板可隱藏至下方 空間利用更極致
- 可堆疊 適合衣服和鞋子的收納



DB-13 (94-01)
370.5W x 260D x 185.5H mm

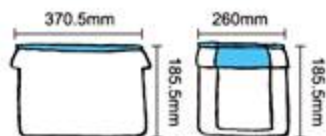
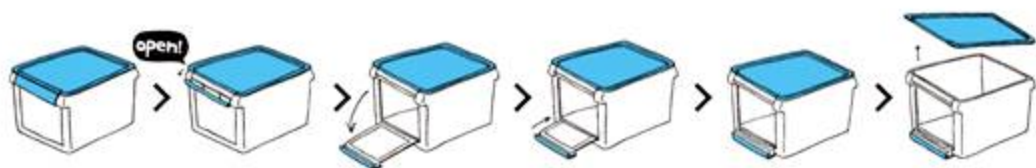

OA 樹德櫃

SC 置物櫃

WB 工作桌

ST 零件櫃

FO 快取盒

CT 工具車

HB 整理盒

TB 工具箱

SH 輕辦公

DD 文具整理

DB 居家收納

MTO 捲簾生產

CB 兒童收納桌椅系列

Children's Storage Stool

安全荷重
建議容量



孩子專用的藏寶基地

讓一直珍惜的玩具藏在裡面，坐在上頭像保護著子民的國王，這裡是屬於寶貝孩子的秘密基地。



顏色:



Just play! Have fun! Enjoy the life!!



大鱷鱷收納桌

CB-46 (95-01)
595W x 423D x 407H mm



⚠ 上蓋荷重30公斤
不適合乘坐



- 收納結合椅凳 雙用途好划算
- 可堆疊以減少封裝尺寸
- 繽紛多色好搭配
- 側邊凹槽設計 開啓和關閉更加容易
- 附矽膠腳墊 止滑安全無顧慮



朵貓貓收納椅凳

CB-16 (95-02)
337W x 282D x 380H mm



⚠ 100公分以下的孩童
不適合乘坐



皮皮蛙收納椅凳

CB-12 (95-03)
287W x 240D x 256H mm



⚠ 90公分以下的孩童
不適合乘坐



孩子們第一個收納好朋友

繽紛的色彩，搭配著可愛的動物造型，像是魔貓，又像是貓頭鷹腦海裡充滿想像力的空間，正是孩子的最大寶藏！



貓頭鷹玩具整理組



MN-HA06 (96-01) 
714W x 485D x 590H mm



EN-HA06 (96-02) 
745.5W x 490D x 590H mm



EN-HA08 (96-03) 
967W x 490D x 590H mm

熊PaPa玩具整理組



BN-HA09 (96-04) 
724W x 411D x 872H mm



BN-HA12 (96-05) 
945.6W x 411D x 872H mm

長頸鹿玩具整理組



GN-HA09 (96-06) 
724W x 468D x 925H mm



GN-HA12 (96-07) 
945.6W x 468D x 925H mm

OA 樹德櫃

SC 置物櫃

WB 工作桌

ST 零件櫃

FO 快取盒

CT 工具車

HB 整理盒

TB 工具箱

SH 輕辦公

DD 文具整理

MN 居家收納

MTO 接盤生產

OA 樹德櫃

SC 置物櫃

WB 工作桌

ST 零件櫃

FO 快取盒

CT 工具車

HB 整理盒

TB 工具箱

SH 輕辦公

DD 文具整理

HA 居家收納

MTO 接單生產

HA 塔塔家置物箱

Stack & Nest Box

轉個圈圈，意外空間疊疊搭起
繞回一圈，不占空間層層收下

想不透的事，只要倒立，便能舉起整個地球，想法將更加清晰。
180度的旋轉，改變了思維也改變了收納方式，輕鬆反轉，結果就不同。



HA-3645K(加蓋) (97-01)
457W x 370D x 260H mm



HA-2328K(加蓋) (97-02)
287W x 235D x 180H mm





HB 家用整理盒系列

Hanging Bins

多變尺寸的魔法空間創造力

縱向與橫向皆可連結搭配，DIY組合出屬於最適合你的小小城堡



1.增加腳柱可以創造更大空間 / 2.並排連接延展收納空間 / 3.可堆疊不占空間 / 4.增加隔板好分類 / 5.可掛在面板上使用

顏色:



安全荷重
建議容量



HB-210 (98-01)
105W x 137D x 76H mm
15 0.6



HB-220 (98-02)
105W x 187D x 76H mm
15 0.8



HB-230 (98-03)
140W x 276D x 127H mm
20 2.7



HB-235 (98-04)
279W x 276D x 127H mm
30 6.4



HB-239 (98-05)
210W x 273D x 178H mm
30 6.6



HB-240 (98-06)
210W x 375D x 178H mm
30 9.6



HB-250 (98-07)
420W x 375D x 178H mm
50 21

OA 樹德櫃

SC 置物櫃

WB 工作桌

ST 零件櫃

FO 快取盒

CT 工具車

HB 整理盒

TB 工具箱

SH 輕辦公

DD 文具整理

FB 居家收納

MTO 接單生產

FB 摺疊籃系列

Folding Basket Series

 安全荷重
建議容量
 



16支鋼釘結合純手工 打造的工匠耐用精神

一秒即可開關的摺疊籃，不佔空間的特色是後車箱的必備物品。



■ 16支鋼釘 純手工組裝

step1 > step2 > step3 > step4

FB-5336 (99-01)  
535W x 361D x 275H mm



FB-4531 (99-02)  
455W x 308D x 240H mm

顏色：白、灰、黑

OB 萬用收納箱 MOQ 1000 個

OB-4736 (93-03)
477W x 353D x 405H mm



■ 增加鎖頭 安全無憂慮

FO 快掀式分類盒 Flip Out Bins



輕拉即出 輕推旋入 輕鬆拿取不費力

生活總有一堆瑣碎的小物困擾著你，我們也是如此
收納不易，一個不小心還會背你而去
因此我們決定不再過著老是翻箱倒櫃的日子
赤裸裸地分類，讓你快眼快手拿取好方便，同時還會有莫名的驕傲感呢！

顏色：



FO-308 (100-01)
303w x 87D x 203H mm
12入/箱



FO-306 (100-02)
303w x 105D x 253H mm
10入/箱



FO-604 (100-03)
603w x 165D x 203H mm
6入/箱



FO-605 (100-04)
603w x 122D x 153H mm
8入/箱



- 1.專利結構設計，防止抽屜因為晃動而滑落。
- 2.透明的前窗，可以清楚的一眼看穿內容物。
- 3.本體特殊填尾槽設計，可以上下左右四方延伸連結。
- 4.預設背掛孔，隨處皆可吊掛。

OA 樹德櫃

SC 置物櫃

WB 工作桌

ST 零件櫃

FO 快取盒

CT 工具箱

HB 整理盒

TB 工具箱

SH 輕辦公

DD 文具整理

FO 居家收納

MTO 接單生產

OA 樹德櫃

SC 置物櫃

WB 工作桌

ST 零件櫃

FO 快取盒

CT 工具車

HB 整理盒

TB 工具箱

SH 輕辦公

DD 文具整理

A9 居家收納

MTO 接單生產

A9 小幫手分類箱

Small Parts Organiser

讓每一個小物件 都有歸屬的小窩

垂直水平分割了你獨特的井然有序，透明感讓你的安排無所遁形
下意識地伸手才驚覺已成為習慣。

A9-1310/ A9-2110
抽屜尺寸

L 內徑 223w x 160D x 85H mm
M 內徑 223w x 160D x 39H mm
S 內徑 86w x 160D x 39H mm

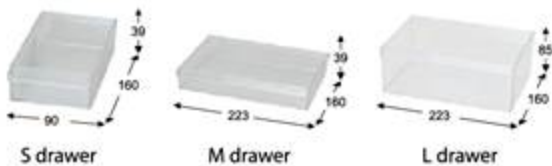

A9-520 (101-01)
374w x 152D x 187H mm
6入/箱



A9-1310 (101-02)
449w x 180D x 247H mm
6入/箱



A9-2110 (101-03)
449w x 180D x 247H mm
6入/箱



SO 小集合收納系列

Vogue Small Parts Organiser

改變生活 從小物整理開始

手工藝的創意與專注力，來自於零件的分類與管理
在每個小小的收納空間，創造無限的魔力

魔力小集合系列



X5

SO-1314 (102-01)
137W x 143D x 36H mm 48入/箱



X10

SO-2714 (102-02)
275W x 143D x 36H mm 24入/箱



SO-2111 (102-03)
210W x 110D x 45H mm
50入/箱



SO-2518 (102-04)
250W x 185D x 40H mm
24入/箱

摩登工藝零件收納盒



CS-1515 (102-05)
145W x 145D x 82H mm
40入/箱



CS-1530 (102-06)
145W x 285D x 82H mm
20入/箱

連環盒系列

食品容器檢驗合格
食研技字第 706501 號



L-40



L-70



L-50

L-40 (102-07)
約 40x 126H mm (6層)
216 個/箱

L-50 (102-08)
約 50x 133H mm (5層)
162 個/箱

L-70 (102-09)
約 70x 110H mm (4層)
135 個/箱

OA 樹德櫃

SC 置物櫃

WB 工作桌

ST 零件櫃

FO 快取盒

CT 工具車

HB 整理盒

TB 工具箱

SH 輕辦公

DD 文具整理

SO 居家收納

MTO 接單生產

PC B5玲瓏盒系列

B5 Stationery Box Series



魔法般的收納力

像一個實在、窩心的朋友，玲瓏和沒有炫麗的外表不多話，卻多了一份沉穩內斂的魅力。

顏色：



B5-PC12 (103-01)
180W x 260D x 215H mm



B5-PC13 (103-02)
180W x 260D x 270H mm

OA 樹德櫃

SC 置物櫃

WB 工作桌

ST 零件櫃

FO 快取盒

CT 工具車

HB 整理盒

TB 工具箱

SH 輕辦公

DD 文具整理

A4 居家收納

MTO 接單生產

PC A4玲瓏盒系列

A4 Stationery Box Series

抽屜種類:



PC-01



PC-02



PC-03



PC-04

PC-1303 (104-01)
250W x 355D x 285H mmPC-1103 (104-02)
250W x 355D x 285H mmPC-2303 (104-03)
275W x 350D x 300H mm

MOQ 800個

PC-2212 (104-04)
275W x 350D x 345H mmPC-1304 (104-05)
250W x 355D x 370H mm

MOQ 800個

PC-1104 (104-06)
250W x 355D x 370H mmPC-2304 (104-07)
275W x 350D x 400H mm

MOQ 800個

PC-2213 (104-08)
275W x 350D x 438H mmPC-1307 (104-09)
250W x 355D x 610H mmPC-1107 (104-10)
250W x 355D x 610H mmPC-2307 (104-11)
275W x 350D x 680H mmPC-2207 (104-12)
275W x 350D x 680H mm

MOQ 400個

TB 家用手提箱系列 Family Leisure

彩色筆畫出的世界 摻著水彩未乾的味道
裹著白膠的黑指紋 沾著操場的喧囂
反覆想起 是那些年的熱鬧

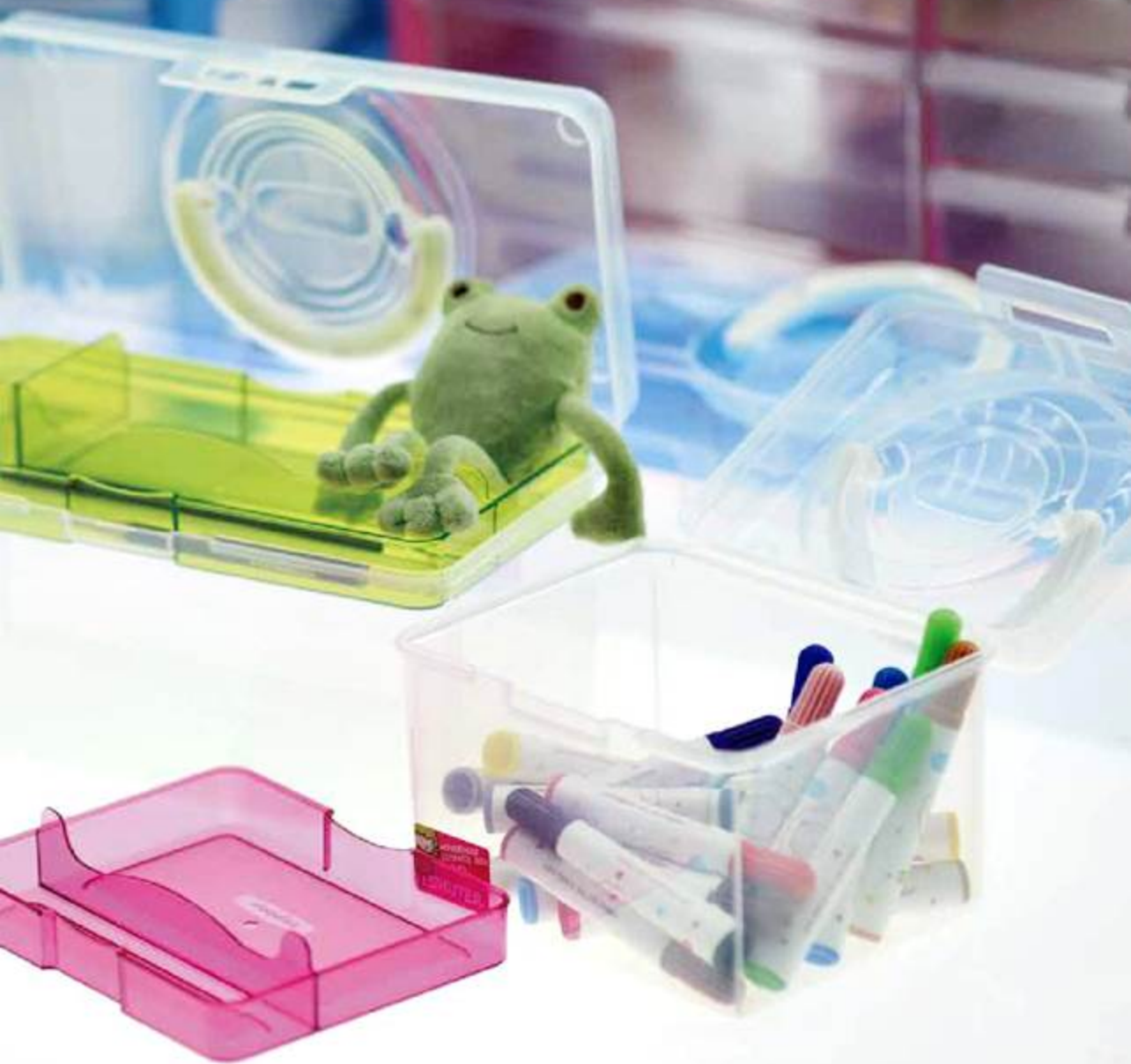

月光系列手提箱

顏色:



TB-200 (106-01)
160W x 137D x 118H mm
6.2"W x 5.4"D x 4.6"H
20入/箱

TB-300 (106-02)
250W x 137D x 129H mm
9.81"W x 5.3"D x 5.1"H
20入/箱



TB-312+TB-200
10入/箱



TB-312 (106-03)
348W x 153D x 139H mm
13.7"W x 6"D x 5.5"H
10入/箱



TB-302 (106-04)
320W x 135D x 110H mm
12"W x 5.3"D x 4.3"H
10入/箱

FUN貝兒手提箱



TB-704 (106-05)
325W x 238D x 91H mm
12.8"W x 9.4"D x 3.6"H
6入/箱

薄霧系列手提箱

顏色:



TB-503 (106-06)
370W x 224D x 190H mm
14.6"W x 8.8"D x 7.4"H
9入/箱

童顏系列手提箱

顏色:



顏色:



TB-733 (內盒) (106-07)
330W x 208D x 150H mm
13"W x 8"D x 6"H
12入/箱



TB-733D (隔片) (106-08)
330W x 208D x 150H mm
13"W x 8"D x 6"H
12入/箱



TB-702 (內盒) (106-09)
256W x 177D x 170H mm
10"W x 7"D x 6.7"H
12入/箱



TB-702D (隔片) (106-10)
256W x 177D x 170H mm
10"W x 7"D x 6.7"H
12入/箱

OA
樹德櫃

SC
置物櫃

WB
工作桌

ST
零件櫃

FO
快取盒

CT
工具車

HB
整理盒

TB
工具箱

SH
輕辦公

DD
文具整理

TB
居家收納

MTO
接單生產

MTO 客製化生產系列



樹德櫃客製區 專屬烤漆，配合企業識別顏色，增加整體感
 門片機能可依需求，增加通氣孔、視窗...等
 最低訂購量 **30** 台 製作交期 **30** 工作天

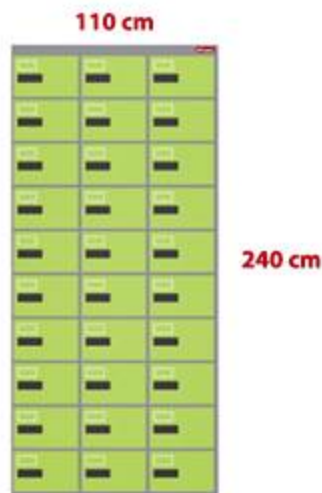
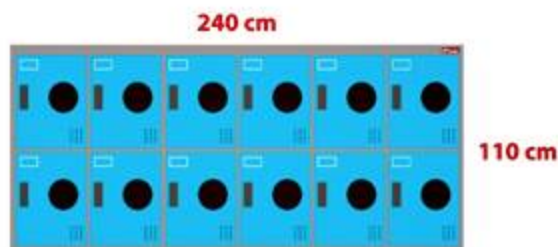

客製化櫃體限制 櫃體可依場地需求，調整高度、深度、寬度
 門片亦可依櫃體寬度或是高度，做平均等分調整
 橫式 最大尺寸 **240W x 70D x 110H cm**
 直式 最大尺寸 **110W x 70D x 240H cm**

A3 落地型樹德櫃系列

MOQ 030 抽屜說明請參考頁面 P.10

高度=74cm



A3-115P (108-01)
370W x 450D x 740H mm



A3M1-7x1 (108-02)
370W x 450D x 740H mm



A3-230P (108-03)
710W x 450D x 740H mm



A3M2-14x2 (108-04)
710W x 450D x 740H mm



A3-345P (108-05)
1050W x 450D x 740H mm



A3M3-21x3 (108-06)
1050W x 450D x 740H mm

A3 落地型樹德櫃系列

MOQ 030 抽屜說明請參考頁面 P.10

高度=106.2cm



A3-122P (108-07)
370W x 450D x 1062H mm



A3-111H (108-08)
370W x 450D x 1062H mm



A3-244P (108-09)
710W x 450D x 1062H mm



A3-222H (108-10)
710W x 450D x 1062H mm



A3-366P (108-11)
1050W x 450D x 1062H mm



A3-333H (108-12)
1050W x 450D x 1062H mm

OA 樹德櫃

SC 置物櫃

WB 工作桌

ST 零件櫃

FO 快取盒

CT 工具車

HB 整理盒

TB 工具箱

SH 輕辦公

DD 文具整理

MB 居家收納

MTO 接單生產

A4 S層板抽系列 **MOQ 030** 抽屜說明請參考頁面 P.09

本產品適用於醫院診所-病歷整理櫃使用

OA
樹德櫃

SC
置物櫃

WB
工作桌

ST
零件櫃

FO
快取盒

CT
工具箱

HB
整理盒

TB
工具箱

SH
輕辦公

DD
文具整理

MB
居家收納

MTO
接單生產



SA4-106P (109-01)
264W x 343D x 287H mm



SA4-B209 (109-02)
534W x 343D x 440H mm



SA4-220P (109-03)
534W x 343D x 483H mm



SA4-112P (109-04)
285W x 343D x 574H mm



SA4-106H (109-05)
285W x 343D x 574H mm



SA4-115P (109-06)
285W x 343D x 740H mm



SA4M1-7x1 (109-07)
285W x 343D x 740H mm



SA4-230P (109-08)
545W x 343D x 740H mm



SA4M2-14x2 (109-09)
545W x 343D x 740H mm



SA4-345P (109-10)
800W x 343D x 740H mm



SA4M3-21x3 (109-11)
800W x 343D x 740H mm



SA4-333H (109-12)
800W x 343D x 1062H mm



SA4-118P (109-13)
285W x 343D x 880H mm



SA4-109H (109-14)
285W x 343D x 880H mm



SA4-236P (109-15)
545W x 343D x 880H mm



SA4-218H (109-16)
545W x 343D x 880H mm



SA4-354P (109-17)
800W x 343D x 880H mm



SA4-327H (109-18)
800W x 343D x 880H mm

A4 O層板抽系列 **MOQ 030** 抽屜說明請參考頁面 P.09

本產品適用於醫院診所-病歷整理櫃使用



A4O-106P (110-01)
264W x 343D x 287H mm



A4O-110P (110-02)
285W x 343D x 483H mm



A4O-112P (110-03)
285W x 343D x 574H mm



A4O-B209 (110-04)
534W x 343D x 440H mm



A4O-220P (110-05)
534W x 343D x 483H mm



A4O-236P (110-06)
545W x 343D x 880H mm



A4O-354P (110-07)
800W x 343D x 880H mm



A4O-366P (110-08)
800W x 343D x 1062H mm

MDF銀木活動櫃 **MOQ 030** 風格品味是我們賣得更好的商品



櫃面波浪紋表面兼具防滑功能 | 人性化高質感不鏽鋼把手 | 無障礙加輪設計活動自如 | **MDF纖維板**，堅固耐用又環保

MDF 生活小常識

依據CNS有關纖維板的標準定義，密度在 0.35~0.8g/cm³ 之間者稱為中密度纖維板 (Medium Density Fiberboard)，在眾多板材中，以中密度纖維板為最常用為製造家具的材料，主要是由於中密度纖維板之密度及加工性質與一般的木材相似，且板材的邊緣光滑，容易切割且切面易處理，因此在家具業中，是美觀、高雅、實用的材料。



B4MD-116P (110-09)
320W x 410D x 820H mm



B4MD-4H8P (110-10)
320W x 410D x 820H mm

北歐電視儲物櫃系列 TV Stand & Storage Combinations

OA 樹德櫃

SC 置物櫃

WB 工作桌

ST 零件櫃

FO 快取盒

CT 工具車

HB 整理盒

TB 工具箱

SH 輕辦公

DD 文具整理

MB 居家收納

MTO 接單生產



在極簡的環境中 享受自在呼吸的美好

把外面的喧囂拋在腦後，回到家就是最平靜的享受。

- 

1. 北歐雜誌架
MCS104 (111-01)
265W x 85D x 1430H mm
- 

2. 北歐櫥櫃
MCV101 (111-02)
305W x 343D x 1562H mm
- 

3. 北歐吊櫃
MCH302 (111-03)
1207W x 216D x 197H mm
- 

4. 北歐電視櫃
TV202 (111-04)
1205W x 475D x 575H mm
- 

5. 北歐書櫃/雜誌櫃
MR134 (111-05)
254W x 254D x 1803H mm

北歐電視儲物櫃系列

MOQ 30台

HB 家用整理箱 **MOQ 1000個**

- 可拆式上蓋 輕鬆堆疊好整理
- 可加腳輪 移動更方便又省力
- 大型收納分類使用

! 超過標準荷重**30kg**，易使上蓋變形。



HB-4068H (112-01)
405W x 645D x 348H mm

30 **50**

安全荷重
建議容量 **KG** **L**

HB 家用整理盒系列



HB-1525H (112-02)
150W x 265D x 121H mm

6 **2.5** **MOQ 30箱**



HB-1218H (112-03)
120W x 180D x 84H mm

3 **1** **MOQ 30箱**

鑰匙管理箱系列 **MOQ 30台**

收藏管理每一把成功的關鍵



20支

KBP-20 (112-04)
195W x 60D x 282H mm



40支

KBP-40 (112-05)
215W x 90D x 325H mm



60支

KBP-60 (112-06)
250W x 90D x 370H mm



120支

KBP-120 (112-07)
250W x 110D x 360H mm



160支

KBP-160 (112-08)
320W x 120D x 400H mm



240支

KBP-240 (112-09)
380W x 120D x 480H mm

OA 樹德櫃

SC 置物櫃

WB 工作桌

ST 零件櫃

FO 快取盒

CT 工具車

HB 整理盒

TB 工具箱

SH 輕辦公

DD 文具整理

MB 居家收納

MTO 接單生產

ESD 抗靜電導電專業零件櫃系列

ESD Antistatic Organise



小改變大保障 保護精密電子

全系列產品皆以工程用全新導電塑料生產品質控管嚴格符合國際ESD(ElectroStatic Discharge)抗靜電規範。

▲ 抗靜電零件櫃系列商品需排單生產

A6 大容量抽系列



CA6-318P (113-01)
533W x 265D x 310H mm



CA6-309H (113-02)
533W x 265D x 310H mm



CA6-224P (113-03)
362W x 265D x 571H mm



CA6-212H (113-04)
362W x 265D x 571H mm



CA6-360P (113-05)
533W x 265D x 937H mm



CA6-330H (113-07)
533W x 265D x 937H mm

CA6-360PD (113-06) 加門型
533W x 313D x 970H mm

CA6-330HD (113-08) 加門型
533W x 313D x 970H mm

A7 耐重抽系列



CA7-324 (113-09)
444W x 222D x 642H mm



CA7-448 (113-10)
586W x 222D x 937H mm

CA7-448D (113-11) 加門型
586W x 270D x 970H mm

A8 經典抽系列



CA8-315 (113-12)
355W x 222D x 415H mm



CA8-560 (113-14)
586W x 222D x 937H mm



CA8-432 (113-13)
466W x 222D x 642H mm

CA8-560D (113-15) 加門型
586W x 270D x 970H mm

附圖櫃接地配件

電阻係數：低於0.1M ohm/SQ
靜電衰減時間：低於0.01秒
表面電阻係數：低於0.1M ohm/SQ
消散材質係數： 10^4-10^9 (可以需求訂製)
導電材質： 10^3-10^5
抽屜材質：PP導電工程塑料

ESD 抗靜電導電專業零件櫃系列說明

適用於精密電子廠提供科技電子零件一個安全的家。
本公司導電系列均以專業特殊導電原料製作，
可依需求訂製 歡迎查詢。

櫃體有深灰、雪白兩色可選擇。
白櫃烤漆需七天交貨期。
所有零件櫃內皆附有隔版，可供自由調整利用。

ST 經典抽系列 抗靜電零件櫃系列商品需排單生產



CST2-330 (114-01)
444W x 222D x 642H mm



CST2-460 (114-02)
586W x 222D x 937H mm

CST2-460D (114-03) 加門型
586W x 270D x 970H mm



CST1-575 (114-04)
586W x 222D x 937H mm

CST1-575D (114-05) 加門型
586W x 270D x 970H mm

HB 整理盒系列

黑色ESD產品上紅色商標信賴的烙印



CHB-1218 (114-06)
121W x 180D x 84H mm

  60pcs/箱



CHB-1525 (114-07)
150W x 265D x 121H mm

  36pcs/箱



CHB-2035 (114-08)
208W x 353D x 155H mm

  18pcs/箱



CHB-2045 (114-09)
205W x 480D x 178H mm

  12pcs/箱



HB-3045 (114-10)
300W x 480D x 178H mm

  12pcs/箱

MOQ

| | |
|----------|-------|
| CHB-1218 | 4000個 |
| CHB-1525 | 2000個 |
| CHB-2035 | 2000個 |
| CHB-2045 | 1200個 |
| CHB-3045 | 1200個 |

ESD 抗靜電整理系列



MOQ 1000個

CA9-520 (114-11)
379W x 151D x 200H mm
抽屜內徑
63W x 134D x 37H mm



CFB-4531 (114-12)
455W x 310D x 240H mm

MOQ 1500個

CFB-5336 (114-13)
535W x 360D x 280H mm

MOQ 1200個

CHA-2328K (114-14)
444W x 222D x 642H mm

MOQ 1800個

CHA-3645K (114-15)
444W x 222D x 642H mm

MOQ 1200個

DC 樹德防潮科技系列

DC dehumidify cabinets

建議容量 

- 高性能除溼指針顯示器
- 無磁害氣密式強化玻璃門
- 活動式自由調整層板
- 1mm粉體塗裝防鏽鍍鋅鋼板
- 耐重水平調整旋鈕

160

DCGH-160 (115-01)
 外寸: 805W x 375D x 590H mm
 內寸: 803W x 350D x 520H mm
 型鋼層板: x 2 **MOQ 5**

各式微電腦顯示器多樣選擇

GH 指針顯示器



濕度顯示
 溫度顯示

CH 燈號顯示器



LED紅黃綠三色時段顯示
 箱內濕度分布精準度為5-8RH%

AH 微電腦數位顯示器



動作指示燈
 濕度調整按鈕
 電源及設定按鈕
 溫/濕度顯示

- 箱內濕氣如超過設定值，微電腦即自動控制晶片動作，集氣凝結集冷板上，箱內濕度減低到設定值後，冷晶片自動OFF，集冷板上即解凍成水珠經導水孔由吸水纖維吸收，並自然蒸發達到除濕效果
- 箱內濕度由微電腦自動調整，控制濕度於RH值30-50之間RH值範圍無法生存適合各物品之保價及珍藏。

- 本系列防潮箱採用半導體晶片，正常使用除溼主機保固5年
- 本系列產品與日本  株式會社 三貴製作所 技術合作

精巧生活防潮箱系列



60

DCGH-60 (115-02)
 外寸: 400W x 410D x 440H mm
 內寸: 395W x 400D x 365H mm
 型鋼層板: x 1 **MOQ 10**



70

DCGH-70 (115-03)
 外寸: 400W x 375D x 550H mm
 內寸: 398W x 350D x 480H mm
 型鋼層板: x 2 **MOQ 10**



115

DCGH-120 (115-04)
 外寸: 400W x 410D x 850H mm
 內寸: 395W x 400D x 760H mm
 型鋼層板: x 2 **MOQ 10**



170

DCGH-193 (115-05)
 外寸: 400W x 410D x 1290H mm
 內寸: 395W x 350D x 1220H mm
 型鋼層板: x 4 **MOQ 5**



80

DCGHA4-103 (115-06)
 外寸: 440W x 407D x 623H mm
 內寸: 400W x 374D x 500H mm
 型鋼層板: x 1 **MOQ 100**



75

DCCH-76 (115-07)
 外寸: 400W x 375D x 580H mm
 內寸: 398W x 350D x 525H mm
 型鋼層板: x 2 **MOQ 5**



87

DCAH-80 (115-08)
 外寸: 400W x 375D x 690H mm
 內寸: 398W x 350D x 520H mm
 型鋼層板: x 2 **MOQ 5**



142

DCGH-142 (115-09)
 外寸: 400W x 375D x 1090H mm
 內寸: 398W x 350D x 1020H mm
 型鋼層板: x 4 **MOQ 5**

大型專業防潮箱



516

DCAH-560 數位 (116-01)
DCGH-560 指針 (116-02)
外寸: 1250W x 485D x 950H mm
內寸: 1248W x 460D x 900H mm
鋼製層板: x 3 **MOQ 3**



310

DCAH-308 數位 (116-03)
DCGH-308 指針 (116-04)
外寸: 905W x 425D x 940H mm
內寸: 903W x 400D x 860H mm
鋼製層板: x 3 **MOQ 3**

310

DCAH-308M 數位 (116-05)
DCGH-308M 指針 (116-06)
外寸: 905W x 425D x 940H mm
內寸: 903W x 400D x 860H mm
鋼製層板: x 3 **MOQ 3**

資料檔案防潮專用櫃系列

- 資料檔案、相片、幻燈片、硬碟之保存是組織企業刻不容緩的首要工作，高濕高溫環境下樹德防潮資料檔案櫃讓您的珍貴資料歷久彌新。



DCAH B4-3DE 數位 (116-07)
DCGH B4-3DE 指針 (116-08)
外寸: 465W x 655D x 1100H mm
內寸: 410W x 557D x 330H mm x3
活動輪: x 4 **MOQ 3**



DCAH B4-4DE 數位 (116-09)
DCGH B4-4DE 指針 (116-10)
外寸: 465W x 655D x 1425H mm
內寸: 410W x 557D x 330H mm x4
MOQ 3

超大型科技防潮櫃系列

- 適合大型醫院、電子工程研究機構、軍方單位使用，可搭配專業儀器設備套件設計，超大容量除濕快又準。上下分離式超強對流除濕。



489

DCAH-490F 數位 (116-11)
DCGH-490F 指針 (116-12)
外寸: 600W x 705D x 1374H mm
內寸: 598W x 680D x 1204H mm
活動輪: x 4 高約: 10cm
鋼製層板: x 3 **MOQ 3**



740

DCAH-760L 數位 (116-13)
DCGH-760L 指針 (116-14)
外寸: 600W x 705D x 1890H mm
內寸: 598W x 680D x 1820H mm
活動輪: x 4 高約: 10cm
鋼製層板: x 5 **MOQ 3**



980

DCAH-980F 數位 (116-15)
DCGH-980F 指針 (116-16)
外寸: 1200W x 705D x 1374H mm
內寸: 1198W x 680D x 1204H mm
活動輪: x 4 高約: 10cm
鋼製層板: x 3 **MOQ 3**



1470

DCAH-1400F 數位 (116-17)
DCGH-1400F 指針 (116-18)
外寸: 1200W x 705D x 1890H mm
內寸: 1198W x 680D x 1820H mm
活動輪: x 4 高約: 10cm
鋼製層板: x 5 **MOQ 3**

建議容量 L

OA 樹德櫃

SC 置物櫃

WB 工作桌

ST 零件櫃

FO 快取盒

CT 工具車

HB 整理盒

TB 工具箱

SH 輕辦公

DD 文具整理

MB 居家收納

MTO 接單生產

樹德專業客製化定製品

▲ 產品可依客戶量身設計，請來電詢問。

Professional Customization

WB 專業工作桌系列



WL4M+W12 (117-01)
1200W x 630D x 1536H mm



WH5M22SC (117-02)
1500W x 750D x 2017H mm

FC 儲物櫃系列



FC-S01 (117-03)

ST 零件櫃系列



(117-04)
THD-A9520-10
800W x 200D x 1130H mm



A9-520 x10
374W x 152D x 187H mm

TB 工具袋系列 600Dx600D 防水尼龍布



工具收納背包 TBP-40 (117-05)
460W x 170D x 520H mm



耐重拉桿袋 TBA-45 (117-06)
460W x 170D x 520H mm



鋼製握把袋 TBS-22 (117-07)
420W x 210D x 250H mm

DP 專業展示架系列

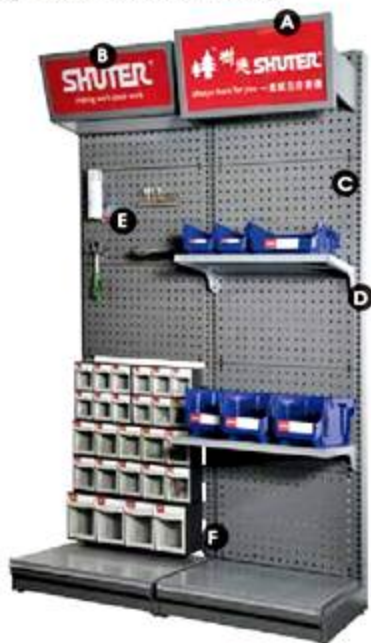

- A** Logo標示牌 **B** Logo燈箱 **C** 方孔掛板
D 層板 **E** 工具掛勾 **F** 單架式掛板



DP-6721 (118-01)
670W x 540D x 2140H mm



DP-4313 (118-02)
430W x 400D x 1365H mm

GR 專業砂輪架



GR-6558 (118-03)
653W x 600D x 1460H mm

HB 整理盒移動輪



HB-C (118-04)

TB 專業工具箱



OA 樹德櫃

SC 置物櫃

WB 工作桌

ST 零件櫃

FO 快取盒

CT 工具車

HB 整理盒

TB 工具箱

SH 輕辦公

DD 文具整理

MB 居家收納

MTO 接單生產

小屋子整理箱系列 Drop-down Door Storage

小屋子

DB-13
370.5W x 260D x 185.5H mm

大房子

DB-26
370.5W x 520D x 185.5H mm



new!
即將
上市

巧立面紙盒 Tissue Stand

TS-300
129.4W x 127.4D x 257H mm
寬度不含書檔組合



書檔組裝說明



1 掀起上蓋



2 向上抽取出書檔底片



3 本體翻至背面，書檔底片對齊底部開口

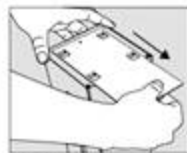

4 往側邊拉



5 完成

